



Shipboard Modular Refrigerator

Technical Manual

Installation, Operation, and Maintenance Instructions

Models:

R41-2M-SN-MLR(FRC)

REV. 001



Table of Contents

<p>List of Illustrations..... 3</p> <p>List of Tables..... 4</p> <p>Chapter 1 General Information..... 5-7</p> <p> 1.1 Introduction..... 5</p> <p> 1.2 Scope of the Manual..... 5</p> <p> 1.3 Equipment Description..... 5</p> <p> 1.4 Equipment Supplied..... 5</p> <p> Table A Leading Particulars..... 6</p> <p> Illustration 1.A—General Arrangement Drawing 7</p> <p>Chapter 2 Operation..... 8</p> <p> 2.1 Introduction..... 8</p> <p> 2.2 Controls and Indicators..... 8</p> <p> Table B Controls and Indicators..... 8</p> <p> Illustration 2.A—Control Panel Assembly.. 9</p> <p> Illustration 2.B—Condensing Unit Assembly 9</p> <p> 2.3 Start Up Procedure..... 10</p> <p> Table C Start Up Procedure..... 11</p> <p> 2.4 Shut Down Procedure for Short Term..... 12</p> <p> Table D Shut Down Procedure for Short Term..... 12</p> <p> 2.5 Cleaning Instructions..... 12-13</p> <p> 2.6 Extended Period Inactivity..... 13</p> <p> Table E Shut Down Procedure for Extended Period 13</p> <p>Chapter 3 Functional Description..... 14</p> <p> 3.1 System Description..... 14</p> <p> 3.2 System Operation..... 14</p> <p>Chapter 4 Scheduled Maintenance..... 15-17</p> <p> 4.1 Introduction..... 15</p> <p> 4.2 Preventive Maintenance Action Index..... 15</p> <p> 4.3 Preparation for Maintenance..... 15</p> <p> 4.4 Maintenance Procedures..... 15</p> <p> A. Monthly Maintenance Requirements.. 15</p> <p> B. Bi-Monthly Maintenance Requirements. 16-17</p> <p> C. Annual Maintenance Requirements.. 17</p> <p> D. 3-Year Maintenance Requirements.. 17</p> <p> Table F Preventive Maintenance Action Index..... 18</p> <p>Chapter 5 Troubleshooting..... 19</p> <p> Table G Mechanical & Electrical..... 19</p> <p>Chapter 6 Corrective Maintenance..... 20</p> <p> 6.1 Introduction..... 20</p> <p> 6.2 Repair Procedures..... 20</p> <p> 6.2.1 Compressor Fan Motor..... 20-22</p>	<p> 6.2.2 Low Pressure Control..... 22</p> <p> 6.2.3 Thermal Expansion Valve (TXV)..... 23</p> <p> 6.2.4 Filter Dryer..... 23</p> <p> 6.2.5 Condenser Fan Motor..... 23</p> <p> 6.2.6 Condenser Fan Blade..... 24</p> <p> 6.2.7 Anti-Condensate Heater Wire..... 24</p> <p> 6.2.8 Door Latch..... 24</p> <p> 6.2.9 Door Hinge..... 25</p> <p> 6.2.10 Door Gasket..... 25</p> <p>Chapter 7 Parts List..... 26-28</p> <p> 7.1 Introduction..... 26</p> <p> 7.2 Source Codes..... 26</p> <p> Table H Source Codes..... 26</p> <p> Table I Parts List R41-2M-SN-MLR(FRC)..... 27-28</p> <p> Illustrations 7.A—7.B Condensing Unit Assembly 29</p> <p> Illustrations 7.C—7.E Evaporator Coil Assembly 30</p> <p> Illustrations 7.F—7.G Electronic Controller Assem- 31 bly.....</p> <p> Illustrations 7.H—7.K Door Detail..... 32</p> <p> Illustration 7.L Interior Detail..... 33</p> <p> Illustrations 7.M—7.P Main Unit Front/Rear 34</p> <p>Chapter 8 Installation..... 35</p> <p> 8.1 Unpacking..... 35</p> <p> 8.2 Installation..... 35</p> <p>Chapter 9 Modular Installation..... 36</p> <p> 9.1 Introduction..... 36</p> <p> 9.2 Installation Skill Level..... 36</p> <p> 9.3 Tools..... 36</p> <p> 9.4 Primary Components..... 36</p> <p> 9.5 Disassembly..... 36-38</p> <p>Chapter 10 Electrical & Mechanical..... 39-41</p> <p> 10.1 Introduction..... 39</p> <p> Illustration 10.A—Mechanical Piping Diagram 40</p> <p> Illustration 10.B—Electrical Schematic (Electronic 41 Controls).....</p> <p>Chapter 11 Warranty..... 42</p> <p>Appendix 1 Revision History..... 43</p>
---	--

List of Illustrations

Figure	Title	Pg.
1.A	General Arrangement Drawing — R41-2M-SN-MLR(FRC)	7
2.A	RWTT65-PM(L), Electronic Controller Assembly Detail	9
2.B	RUT520-2-PM, Condensing Unit Assembly	9
7.A	Condensing Unit Assembly, RUT520-2-PM, Left Side View	29
7.B	Condensing Unit Assembly, RUT520-2-PM, Right Side View	29
7.C	Evaporator Coil Assembly, RWE040-PM, Lower View	30
7.D	Evaporator Coil Assembly, RWE040-PM, Interior Detail	30
7.E	Evaporator Coil Assembly, RWE040-PM, Fan Motors Detail	30
7.F	RWTT65-PM(L), Electronic Controller Assembly, Front Detail	31
7.G	RWTT65-PM(L), Electronic Controller, Interior Rear Detail	31
7.H	Door Assembly Detail	32
7.I	Door Hinge/Interior Detail	32
7.J	Door Latch Detail	32
7.K	Door Strike Detail	32
7.L	Interior Detail	33
7.M	Main Unit-Front Detail View	34
7.N	Main Unit-Rear Detail View	34
7.O	Accessories-Shelf & Shelf Clips Detail	34
7.P	Leg Detail	34
10.A	Mechanical Piping Diagram	40
10.B	Electrical Schematic (Electronic Controller)	41

List of Tables

Figure	Title	Page
A.	Leading Particulars	6
B.	Controls and Indicators	8
C.	Start Up Procedure	11
D.	Shut Down Procedure for Short Term	12
E.	Shut Down Procedure for Extended Period	13
F.	Preventive Maintenance Action Index	18
G.	Mechanical and Electrical Troubleshooting Guide	19
H.	Source Codes	26
I.	Parts List - R41-2M-SN-MLR(FRC)	27-28

Chapter 1 – General Information

1.1 Introduction

This technical manual provides information on the installation, operation, maintenance, and inspection of this unit manufactured by **Cospolich Inc.**, Destrehan, Louisiana. A complete parts breakdown is provided in Chapter 7.

1.2 Scope of the Manual

This technical manual provides information for installation, operating, preventative maintenance, and service instructions, including applicable drawings and figures of the equipment.

1.3 Equipment Description

The unit consists of the following parts:

- A. Storage Compartment - The storage compartment is clear storage area. Included in this area are the adjustable shelves.
- B. Door(s) – Access to the storage compartment is through hinge mounted door(s).
- C. Condensing Unit & Controls Compartment- The condensing unit and controls compartment is located below the storage compartment of the cabinet. Access to this compartment is through an removable grill on the front left of the cabinet.
- D. Evaporator Coil Assembly– The evaporator coil assembly is located in the storage compartment and is responsible for distributing the cold air associated with the refrigeration system.
- E. Cabinet - The cabinet is the enclosure in which all of the above items are housed.

1.4 Equipment Supplied

The unit is shipped from the factory fully assembled, palletized and crated to minimize the possibility of damage in shipping and storage.

Table A – Leading Particulars

MANUFACTURER:	Cospolich Inc. Destrehan, Louisiana 70047
TYPE:	Marine Shipboard Modular Refrigerator Unit
MODEL:	<div style="border: 1px solid black; padding: 5px; width: fit-content; margin: 0 auto;"> <p>R41-2M-SN-MLR(FRC)</p> <p>REV. 001</p> </div>
PURPOSE:	Storage of Refrigerated Food Items/Perishables
ELECTRICAL REQUIREMENTS:	Power Supply - 115 Volt AC, 60 Hz, 1 Phase Amp draw - RLA: 10.1 Amps - Max Fuse: 20 Amps
REFRIGERANT:	404A
CHARGE:	2 lbs., 4 ozs
DRAIN:	Not Required
DIMENSIONS:	51" WIDE X 29" ACTUAL CABINET DEPTH X 72" HIGH

Illustration 1.A – General Arrangement Drawing

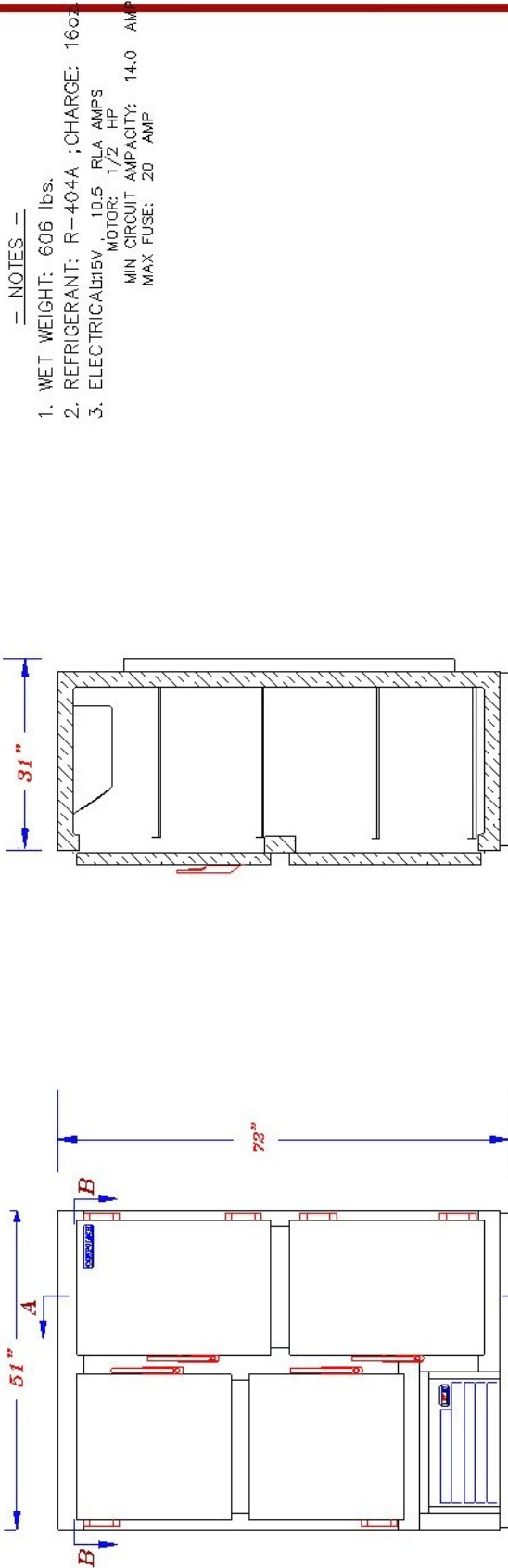

- NOTES -
1. WET WEIGHT: 606 lbs.
 2. REFRIGERANT: R-404A ; CHARGE: 16oz
 3. ELECTRICAL: 115V, 10.5 RLA AMPS
MOTOR: 1/2 HP
MIN CIRCUIT AMPACITY: 14.0 AMP
MAX FUSE: 20 AMP

MODEL **R41-2M-SN-MLR (FRC)**
SPECIFICATION

DIMENSIONS: Width **51"** Depth **31"** Height **72"**
Finish: Interior (Impress) **S.S.** Interior **S.S.**
INSULATION: **POLYURETHANE, FOAMED-IN-PLACE**
REFRIGERATION:
ELECTRICAL: **115VAC, 1 PHASE, 60 Hz**
SPECIAL PROVISIONING:

Half Doors
OMNI-STAT digital thermometer and controller
Seven (?) stainless steel shelves w/sea rails

NOTES:
REVISIONS:

Fabrication can proceed according to these specifications, except as noted.

ITEM **MODULAR REFRIGERATOR**

PROJECT Bollinger FRC Program	DWG # 92414
DATE 06/14/2010 SCALE -	DWN. BY EL
COSPOLICH, INC.	
DESTREHAN, LA	

SECTION "A-A"

ELEVATION

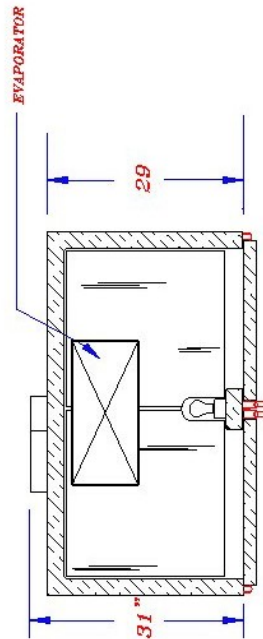

SECTION "B-B"

Approved By: _____

Date: _____

Chapter 2 – Operation

2.1 Introduction

These models are heavy-duty pieces of food service equipment designed for intermittent use. They incorporate electronic controls to regulate the cycling and temperature of the refrigeration system.

2.2 Table B—Controls and Indicators

Name	Type	Function
Power Switch	Toggle Switch	Power Control, terminates all electrical into and past the supply cord
Electronic Controller	Push Button Electronic, Digital Display	Cycles Refrigeration System (Automatic)
Low Pressure Switch	Contact Points	Cycles the refrigeration system in instances of low refrigerant
Suction Valve	Manual Plunger Valve	Isolate suction at the compressor
Discharge Valve	Manual Plunger Valve	Isolate Discharge line at receiver

Note: Normal operating pressures in 90°F ambient environments for refrigerator applications (37°F Cabinet temperature) should be 40-65 psi Suction Pressure and 300-375 psi Head Pressure.

Note: Operating pressures are affected by ambient conditions, product load, and the condition of the equipment.

Illustrations 2.A, 2.B— Electronic Controller & Condensing Unit Assemblies



Illustration 2.A: RWTT65-PM(L)
Electronic Controller Assembly



Illustration 2.B:
RUT520-2-PM
Condensing
Unit Assembly

2.3 Start Up Procedure

The refrigeration system is completely factory assembled, pre-charged, and ready for operation. To energize the unit, it is only necessary to find the power supply cord and connect it to a proper 115V power source. Once the supply cord has been connected to a power source, the unit can be started by flipping the power control switch to the "ON" position.

NOTE: *On modular units (MLR suffix in model number) the equipment will require dismantling.*

Table C – Start Up Procedure

	Operation	Results
1.	Activate system by connecting electrical service cord to power supply.	This brings power to the control. The compressor should immediately come on line along with the condenser fan and the evaporator fan(s)
2.	Place power switch to "ON" position	This brings power to the controls.
3.	Locate liquid refrigerant indication glass mounted on the receiver	Once the system has been operating for two minutes, the glass should appear clear and full of liquid refrigerant.
4.	Wait 15 minutes	The temperature in the storage area should begin to drop.
5.	Wait 3 hours	Once the operating temperature has been reached, stocking of the cabinet are can begin.

2.4 Shut Down Procedure for Short Term

To shut down, switch the power control to the off position.

Table D—Shut Down Procedure for Short Term

	Operation	Results
1.	De-energize the system by flipping the power control switch "OFF".	Once the system is de-energized the cabinet has no power.



WARNING: PRIOR TO CLEANING ANY OF THE UNIT, THE SYSTEM SHOULD BE DEACTIVATED BY DISCONNECTING THE POWER SUPPLY.

2.5 Cleaning Instructions

1. It is necessary that the power source be turned off.
2. Remove all shelves.
3. Wipe entire unit using a clean cloth or sponge with a mild detergent.



WARNING: DO NOT SPLASH OR POUR WATER ONTO THE EVAPORATOR ASSEMBLY, CONTROL PANEL, CONDENSING UNIT AND/OR WIRING.



CAUTION: POSSIBLE SHOCK HAZARD MAY RESULT AND UNIT MAY BE DAMAGED SHOULD ELECTRICAL COMPONENTS BECOME WET.

4. A plastic scouring pad may be used in the storage area to remove any hardened food particles.
5. When cleaning is finished, rinse the inside thoroughly with a solution of vinegar and water to neutralize all detergent/cleaner residue.

Important: It is not recommended to use any strong or caustic cleaners on the Refrigerator. Do not allow ammonia to stand in the interior of the unit. Make certain to rinse thoroughly to remove all residue. Failing to do so may cause damage or corrosion to the unit.

2.6 Preparation for an Extended Period of Inactivity

This unit is designed for periodic use. For extended shut down the electrical should be disconnected and the interior cleaned.

Table E— Shut Down Procedure for Extended Period

	Operation	Results
1.	Fully close discharge valve at the receiver	Compressor will pump liquid refrigerant from system to receiver.
2.	Fully close suction valve at the compressor	This will isolate the refrigerant between the two valves.
3.	De-energize the system by flipping the power control switch to the "OFF" position and disconnecting the electrical supply cord.	De-energizes system. The condenser fan and evaporator fan(s) will cease operation.
4.	Clean and wipe dry the food storage compartment	This will reduce the odor buildup during shut down period.

Chapter 3 – Functional Description

3.1 System Description

The unit is a self-contained, automatically controlled, continuous duty perishable food storage system. It is designed with the intent and purpose of storing perishable food items.

The operating temperature is automatically monitored by the electronic controls that are factory set to maintain a predetermined adequate storage condition.

The equipment is comprised of the following two basic compartment assemblies:

1. Condensing Unit Compartment—This area contains the condensing unit along with the electronic controller assembly.
2. Storage Compartment—The insulated food storage area is a temperature controlled refrigerated area. Included in this compartment is the adjustable shelving and evaporator coil assembly.

3.2 System Operation

The design of the refrigerator cabinet focuses primarily on the safe storage of food products requiring refrigeration. In engineering, considerable attention was placed on not only its functionality, but also serviceability.

The refrigeration system is a closed loop system. Barring a leak in the system, the addition of refrigerant will not be necessary. A periodic check of the refrigerant level, however, is recommended to insure that the system operates at the optimum level at which it was designed.

The chilled food compartment is designed for the storage of perishable food items that require a temperature range of 37 to 40°F on refrigerators and –5 to 0°F on freezers. It is a general rule that adequate spacing is allowed between the stored items to allow for proper air circulation.

Chapter 4—Scheduled Maintenance

4.1 Introduction

To insure the longest and most trouble free operation, a thorough periodic maintenance schedule is required. The maintenance system should be aimed at maximizing the efficient utilization of maintenance personnel, minimizing down time, and providing the orderly acquisition of spare parts support.

The Cospolich refrigerator cabinet will generally be in operation in a facility or onboard a vessel where scheduled maintenance is performed according to Maintenance Index Plans. This unit requires regular maintenance. This chapter is intended as an alternative to any standard maintenance program that may pre-exist. The preventative maintenance schedule is based upon similar maintenance requirements for commercial refrigeration equipment.

4.2 Preventive Maintenance Action Index

If there is not a maintenance index plan, we have formulated our schedule for periodic maintenance in Table G.

4.3 Preparation for Maintenance

Since many areas affected in the maintenance schedule are electrically supplied, it may be necessary to de-energize the system when making these inspections.

4.4 Maintenance

A. Monthly Maintenance

1. The unit should first be de-energized by switching the toggle switch to the "OFF" position. The switch is found on the electronic control panel assembly in the condensing unit compartment. **Note:** *It is necessary to first remove the louvered grill to the condensing unit compartment. This is done by lifting it straight up, then pulling the bottom out and down.*
2. Using a vacuum or soft brush/broom, brush the condenser fins in a vertical motion to remove dust or debris.

B. Bi-Monthly Maintenance

1. Check the drain line at both the inlet and outlet ends to make certain that there are no obstructions (forced air evaporator models only). It is not recommended to use any chemicals in clearing a clogged drain. The preferred method is to use compressed air, with approximately 60 psi being sufficient to free most clogs or obstructions. To do so, simply remove the drain line at the evaporator coil and attach an air line to it.
2. With the unit in a cooling cycle, use a flashlight and locate the refrigerant sight glass. If the compressor has been running for 3 or more minutes, there should be no visible bubbles.

A. If bubbles are present:

- Determine if there is a leak by using an electronic leak detector.
- Repair any/all leak(s).

Warning: *The system should be de-energized when checking for leaks.*

B. To repair leaks:

1. Flared Fitting: Can often be repaired by simply tightening the brass flare nut 1/4 of a turn. If tightening does not repair the leak, it may be necessary to re-flare the tubing.
2. Brazed Joint: It is necessary to pump down the system's refrigerant charge to remedy the problem. To pump the refrigerant into the receiver, you must first connect service gauges to the system at the suction valve on the compressor and the liquid valve on the receiver. Purge the gauges before opening the systems valves to avoid contamination. Run the receiver (liquid or high pressure) valve all the way in to stop the refrigerant from exiting the receiver. The system must be pumped down to a vacuum prior to opening. Once pumped down, the necessary repairs can be made.

3. Using a mild non-abrasive detergent and soft cloth, wipe the interior lining beginning with the top and working down. Also, wipe the gasket and where it sits on the cabinet interior.
4. De-energize the condensing units. With the units de-energized, check the condenser fan motor and make certain that it is secure and not loose. Inspect the fan blade for cracks and make sure it is tight on the motor.
5. To inspect the evaporator motor, de-energize the unit. Remove the drain line from the evaporator pan. Loosen the screws that hold the shroud. Lower the shroud and disconnect the polarized electrical connection. With the shroud out of the cabinet, proceed to inspect the motor mounting bolts and the fan for cracks or excessive play. **NOTE:** *In vertical style evaporators, lift/remove the side cover to examine the evaporator fans, which should be clearly visible and accessible.*
6. Using a mild detergent and water, wipe the vinyl gasket. Make certain to clean under the gasket to remove any mildew or residue that may have accumulated.
7. Using a mild, non-abrasive detergent and water, wipe the cabinet exterior, paying careful attention to wipe the cabinet in the direction of the stainless steel grain texture.

C. Annual Maintenance

1. Locate the condensing units and check all refrigerant lines for leaks or fatigue, making sure no copper lines are in direct contact with any other metal surfaces. If contact exists, place an insulated material between the two surfaces.
2. Inspect electrical connections to make certain that there is a good contact and that wires are neither weakened or frayed.
3. Inspect the integrity of the cabinet.
4. Check all bolts and screws to make sure they are tight and secure.

D. 3-Year Frequency Maintenance

1. Replace all door gaskets. To do so, first remove all products from the refrigerated compartment. Using a Phillips screwdriver, remove the door from the cabinet and lay it on a flat surface, gasket facing up. Lift the flange off the gasket and remove all screws securing it to the door. Remove the original gasket and replace with a new one. Reinstall all screws and mount door back onto cabinet.
2. Inspect all motors and shafts for noise & wear, replace if necessary.
3. With the unit de-energized, remove the condensing unit from its compartment and inspect all wiring for signs of fatigue or wear.
4. Inspect the operation of the door latch assembly (when applicable). Check for signs of wear, loose screws, or mechanical failure.
5. Inspect the operation of the door hinges. To do so, open the door at a 90° angle to the cabinet and lift on the outer edge of the door. If there is upward movement of ½" or more, replace the hinges. On spring-mount hinges, when the doors no longer close properly, replace the hinges.

Table F – Preventive Maintenance Action Index

	Frequency	Description
1.	Monthly	A. Inspect condenser coil to make certain air flow is not obstructed and that it is clear of dust and debris.
2.	Bi-Monthly	A. Inspect and clear drain line. B. Check the liquid refrigerant sight glass for proper refrigerant charge C. Clean interior and exterior of cabinet with mild detergent and water, dry thoroughly D. Check both condenser fan motor and evaporator motor(s) for proper function and that they are mounted securely E. Clean door gaskets and breaker strips with a damp cloth
3.	Annually	A. Slide out condensing unit, check all joints and fittings for signs of wear, leaks, or fatigue B. Inspect electrical connections to make certain that there is a good contact and that wires are neither weakened or frayed. C. Check the integrity of the cabinet
4.	3-Year	A. Replace all door gaskets B. Inspect motor shafts for noise or wear C. Inspect electrical controls and wiring D. Inspect door latch (when applicable) and hinges.

Chapter 5 – Troubleshooting

This chapter will assist in a systematic check of components in determining any cause of equipment failure.

It will be necessary that the individual involved in the troubleshooting operation be familiar with the function of the equipment as described in Chapter 3.

The following table lists the most common symptoms that may be experienced and the recommended corrective action. The tables are separated into electrical mainte-

Table G – Mechanical and Electrical Troubleshooting Guide

Symptom	Possible Failure	Remedy
Unit does not operate	A. Control failure B. Incorrect voltage C. Failed compressor	A. Adjust control or replace B. Correct C. Replace
Unit runs continuously	A. Control failure B. Bad connection at TXV expansion valve C. Restricted air flow D. Bad condenser fan motor E. TXV valve stuck open F. Ineffective door seal G. Restricted air flow in storage compartment	A. Adjust control or replace B. Check and secure sensor bulb to suction line C. Clear obstruction and clean condenser D. Check and replace E. Replace F. Adjust door latch and hinges G. Redistribute food for even air flow
Low Head Pressure	A. Defective compressor B. Low refrigerant C. Ambient temp too low	A. Replace B. Leak check & recharge C. Raise room temperature
High Head Pressure	A. Dirty condenser B. System contains air C. Refrigerant overcharge D. Condenser fan bad	A. Clean condenser B. Evacuate, change filter dryer, recharge C. Reduce qty of refrigerant D. Replace
Short Cycling	A. Maladjusted control	A. Adjust control

Chapter 6 – Corrective Maintenance

6.1 Introduction

This chapter focuses on the instruction needed in the removal and replacement of certain components. We will also address the repair of components not listed under the schedule maintenance index covered in Chapter 4.

The components that we address are considered acceptable for repair using standard procedures that we will detail. The level of skills required to perform the service or repair will vary. Some may require specific training. It is up to the individual and /or his supervisor to determine their capability to undertake the particular task of service or repair. It is also important to know that any procedure requiring the handling of electrical components and appliances. The service or repair items are limited to those listed in Chapter 7.

6.2 Repair Procedure

****WARNING****

PRIOR TO PERFORMING ANY WORK ON THE SYSTEM, IT IS REQUIRED THAT THE UNIT BE DE-ENERGIZED.

***Note:** To access the electrical components the louvered grill on the front of the cabinet must be removed. To remove it, simply lift up and pull the bottom of the grill outward.*

6.2.1 Replacement of Compressor (Part #: RUT522)

1. Evacuate the refrigerant from the system using a recovery system in compliance with all Federal regulations.
2. Disconnect power supply to the unit.
3. Remove the exterior louvered grill to access the condensing unit compartment.
4. With the grill(s) removed, use a 3/8" wrench/socket to remove the mounting bolts that secure the condensing unit to the cabinet base. Slide entire unit out, paying attention to lift it over the angle mounting clips at the base.
5. Find electrical terminal box on side of compressor and remove cover. Disconnect the wires from the compressor. Remove the screws that attach terminal box to the compressor. The compressor is now electrically detached.

6. Using wrenches, remove the suction and discharge valve stem cover caps on each side of the compressor. Also remove the cap nut on the suction and discharge side as well.
7. Disconnect high-side line at the compressor. This is done by heating the brazed connection using an acetylene and oxygen torch set. **Note:** *Do not apply a flame to lines containing refrigerant as dangerous and toxic phosgene gas may be created.*
8. To remove the low pressure control capillary tube and service fitting, loosen the ¼" brass flare nut on the suction valve.
9. Disconnect the compressor from its mounting. Remove the wire clips on each of the four feet. Remove old compressor.
10. To install the new compressor, place it in position on the base and reinstall four wire clips.
11. Reattach the suction and discharge valve blocks to the appropriate sides of the compressor.
12. Reattach the low pressure control capillary tube and service fittings to the suction side of the compressor.
13. Reattach the suction line to the compressor.
14. Prepare the high pressure line's end by cleaning off residue using a fine sandpaper or emery cloth. Also clean the connection on the compressor. Apply flux to both ends and braze the connections into place.
15. Remove valve stem cap from suction block on side of the compressor. Run valve stem out all the way then in one turn clockwise.
16. Place refrigeration service gauge hoses on both suction and high side valves. Attach a bottle of refrigerant to the charging hose and charge the system with 10 psi of 404a, then using N², bring pressure up to 150 psi. Use an electronic leak detector to check system for leaks. Repair all leaks, if necessary.
17. If no leaks are present, recover the test charge using a vacuum recovery pump.

18. With the system pressure at 0 psi, connect the vacuum pump and evacuate the system. Run pump for 1 hour. Pump should pull system down to 29.72" Hg (NSTM 516 requires evac of 5000 microns, 29.72" Hg).
19. Reattach electrical terminal box and secure all wiring.
20. Check refrigeration tag on the unit for the number of ounces of refrigerant to place into the system for start up. Monitor the pressure on both the suction and discharge sides of the manifold gauges. As the temperature in the storage area begins to fall, check the refrigerant flow through the sight glass. The unit is fully charged when there are no bubbles in the sight glass. If after five minutes of operation, bubbles are still present, it may be necessary to add more refrigerant, which should be done in small amounts to keep from overcharging.

Warning: *Overcharging a refrigeration system can be dangerous. If assistance is required, call Cospolich (800) 423-7761 to speak to a service technician.*

6.2.2 Low Pressure Control (Part #: RWPL02)

1. Disconnect the unit from electrical service.
2. Remove control cover and disconnect electrical terminals.
3. Disconnect capillary tube.
4. Remove mounting fasteners on control base and install new control.
5. To adjust the new control, hook up service gauges to the suction and discharge valves and crack them to allow the gauges to detect a reading.
6. Using a standard screwdriver, coarse adjust the control by turning the adjustment screws on the top of the control. Preset the cut-in and cut-out at 0 psi and 10 psi respectively for a refrigerator (and 0 psi and 10 psi respectively for a freezer, when applicable).

NOTE: *If your unit does not contain a thermostat, please contact Cospolich Customer Service at (800) 423-7761 for your cabinet's appropriate settings.*

7. Start the system and allow it to run for five minutes. Monitor the low side pressure. Fine adjustments may be necessary to achieve the proper cycling pressures.

6.2.3 Replacing Expansion Valve (TXV)—(Part #: RWEV30)

1. Close liquid valve and run compressor until it pumps refrigerant into the receiver (low side service gauge will read 1 psi). Close the suction line valve. It may be necessary to jump out the pressure switch in order to achieve the 1 psi reading.
2. Disconnect the sensor bulb connections at the suction line.
3. Disconnect the liquid line (1/4") and suction line (3/8") then remove the TXV.
4. Install new TXV, reconnect lines, and re-install the sensor bulb.
5. Purge system and add refrigerant, if needed.

6.2.4 Replacing Filter Dryer— (Part #: RWFD02)

1. Close liquid line valve and run compressor until the low side refrigeration gauge indicates 1 psi, then close suction. It may be necessary to jump out the pressure switch in order to achieve the 1 psi reading.
2. Remove the filter dryer from the system and replace with new dryer.
3. Purge system and add refrigerant, if needed.

6.2.5 Replacing Condenser Fan Motor— (Part #: RWCM62)

1. Disconnect all electrical power to the unit.
2. Remove the condensing unit from its compartment.
3. Remove the protective wire shroud from around the motor.
4. Disconnect fan motor leads from the terminal box on the compressor.
5. Remove the mounting screws at the motor base.
6. Using an Allen wrench, remove the aluminum fan.
7. To install new motor, reverse the process.

6.2.6 Replacing Condenser Fan Blade—(Part #: RWFB08)

1. Disconnect all electrical power to unit.
2. Remove the condensing unit from the its compartment.
3. Locate and remove the five mounting screws attaching the blower trim and frame.
4. Remove protective wire shroud from around the motor.
5. Using an Allen wrench, loosen the set screw on the blade hub and slide the blade from the shaft.
6. Replace the blade. Reverse the process to reassemble.

6.2.7 Replacing the Anti-Condensate Heater(s)—(Part #: L1HR90) (Part #: L1HR104)

NOTE: *The anti-condensate heater wire is located behind the front edge of the vinyl breakers in the door opening.*

1. Disconnect all electrical power to the cabinet.
2. Remove vinyl breaker strips by exerting pressure at the front edge toward the door.
3. Disconnect anti-condensate heater wiring connection.
4. Remove heater from recessed rail.
5. Replace new heater wire in rail and reconnect electrical.

6.2.8 Replacing Door Handle/Latch —(Part #: HXLH06)

1. Remove three side mounting screws in the latch.
2. Remove two screws in the strike.
3. Replace both latch/handle and strike.
4. Replace in reverse order.

6.2.9 Replacing Door Hinge(s)—(Part #: HXHE02)

NOTE: *This procedure is best accomplished with two people—one to hold the door while the other removes and the attachment screws.*

1. Using a screwdriver, remove the three screws that attach the butt section of the hinges to the cabinet.
2. With the door detached from the cabinet, remove the screws that attach the hinges to the door.
3. To install replacement hinges, reverse the process.
4. On spring-loaded hinges (when applicable), careful attention must be paid to the spring cartridge during the replacement process. Call Cospolich (800) 423-7761 for assistance.

6.2.10 Replacing Door Gasket—(Part #s: G22X30DMV, G22X23MV)

NOTE: *It is suggested that the door be removed from the cabinet and placed gasket side up on a table during the replacement process. Pay careful attention not to cut the new gasket when installing.*

1. Pull back gasket and remove all fasteners located below the gasket lip.
2. Clean the area under the gasket.
3. Place new gasket on door, replace all fasteners.
4. Reinstall door onto cabinet.

Cospolich Inc. urges that all individuals responsible for training, teaching or advising, installation mechanics and service personnel emphasize proper techniques and strict adherence to recommended practices for electrical maintenance.

Chapter 7—Parts List

7.1 Introduction

This section of the manual contains lists of replaceable parts. Each of the tables contain a list of removable parts associated with an assembly of the cabinet . No parts identification has been provided for details of permanently assembled items or those items that are not suitable for field repair.

7.2 Source Codes

The sources for some items are shown in the part tabulation. Where no individual source code is listed, the part is available through Cospolich Inc. , PO Box 1206, Destrehan, LA 70047 (Fed. Mfg. Code #66682).

Table H—Source Codes

Code Number	Name	Address
14852	Bohn Heat Transfer	Danville, IL 61834
32761	Kason Industries	Newnan, GA 30265
50992	Ranco Controls	Plain City, OH 43064
78462	Sporlan Valve	Washington, MO 63090
14569	Copeland Corporation	Sidney, OH 45365
17529	Oasis	Vacaville, CA 95687
59431	Tecumseh Products	Ann Arbor, MI 48108
49048	Miljoco Corporation	Mt. Clemens, MI 48043
42020	Nashville Wire Products	White Bluff, TN 37187
79264	Jean's Extrusions, Inc.	Salem, IN 47167
2K223	Refrigeration Hardware	Grand Junction, CO 81505
09966	Instrument Systems Corp.	Jericho, NY 11753
60886	Idec Corporation	Sunnyvale, CA 94089
19220	Eberhard, Inc.	Strongsville, OH 44149
66682	Cospolich, Inc.	Destrehan, LA 70047

Table I—Parts List for R41-2M-S(N)-MLR(FRC)

	ITEM	COSP#	MFG#	Vendor	QTY	U/M
1	LARGE DOOR ASSEMBLY	D1(FRC)	D1(FRC)	COSPOLICH	2	EA
2	LARGE DOOR GASKET	G22X30DMV	6449	TRG	2	EA
3	DOOR HINGE	HXHE02	0217000008	KASON	8	EA
4	DOOR LATCH	HXLH06	172BC	KASON	4	EA
5	LIGHT SWITCH ACTIVATOR	EX96S	EX96S	WRICO	4	EA
6	SHELF CLIP	HXCS01	006600004	KASON	32	EA
7	1/2" DRAIN LINE TUBING	CVT12	CVT12	SASCO	15	FT
8	DEFROST SENSOR, 118"	RWTS15*	077F8798	DANFOSS	1	EA
9	CABINET SENSOR, 118"	RWTS14	077F8769	DANFOSS	1	EA
10	CONDENSER SENSOR, 59"	RWTS13*	077F8760	DANFOSS	1	EA
11	ON/OFF TOGGLE SWITCH	LWTS01	2FA53-73-TABS	ALLIED	1	EA
12	ADJUSTABLE LEG	HLEG63	1-1752F260T50S	KASON	4	EA
13	ELECTRONIC CONTROLLER DIGITAL DISPLAY	RWTT65	ERC102C	DANFOSS	1	EA
14	ELECTRONIC CONTROLLER ASSEMBLY	RWTT65-PM(L)	RWTT65-PM(L)	COSPOLICH	1	EA
15	PREPPED CONDENSING UNIT ASSEMBLY, 115V, 404A	RUT520-2-PM	RUT520-2-PM	COSPOLICH	1	EA
16	CONDENSING UNIT ONLY	RUT520-2	M4CF-0050-IAA-212	EMERSON	1	EA
17	COMPRESSOR	RUT522	RST45C1E-IAA-108	EMERSON	1	EA
18	CONDENSER	RWCD10	066-0336-01	EMERSON	1	EA
19	CONDENSER FAN BLADE	RWFB08	083-0130-00	EMERSON	1	EA
20	CONDENSER FAN MOTOR	RWCM62	050-0300-00	EMERSON	1	EA
21	RECEIVER TANK	RWRT36	577-0346-04	EMERSON	1	EA
22	START CAPACITOR	RWCP85	014-0061-32	EMERSON	1	EA
23	CONDENSING UNIT RELAY	RWRLY85	040-0172-03	EMERSON	1	EA
24	OVERLOAD	RWOVL67	071-0605-09	EMERSON	1	EA
25	SUCTION VALVE	RWSV25	510-0133-09	EMERSON	1	EA
26	FILTER DRYER	RWFD02	C-O52-S	SPORLAN	1	EA
27	PRESSURE SWITCH	RWPL02	010-1483-070	RANCO	1	EA
28	SIGHT GLASS	RWSG09	SA-K142	SPORLAN	1	EA
29	1/4" QUICK CONNECT FITTING	RWQF0048	5500-04-08	PARKER	2	EA

Table I—Parts List for R41-2M-S(N)-MLR(FRC)

	ITEM	COSP#	MFG#	Vendor	QTY	U/M
30	1/2" QUICK CONNECT FITTING	RWQF0088	5500-08-08	PARKER	2	EA
31	PREPPED EVAPORATOR COIL ASSEMBLY, 115V, 404A	RWE040-PM	RWE040-PM	COSPOLICH	1	EA
32	EVAPORATOR COIL ONLY	RWE040	TA23SG	HEATCRAFT	1	EA
33	LATCH STRIKE	HXLH06-S	172-2	KASON	4	EA
34	EVAPORATOR MOTOR	RWEM03	25300701	HEATCRAFT	3	EA
35	EVAPORATOR FAN BLADE	RWE5101B	5101B	HEATCRAFT	3	EA
36	EVAPORATOR FAN COVER	RWE5054D	5054D	HEATCRAFT	3	EA
37	EXPANSION VALVE	RWEV30	FS-1/2-C	SPORLAN	1	EA
38	COPPER TUBING WHEEL	RWCTW05M	RWCTW05M	COSPOLICH	1	EA
39	STAINLESS STEEL SHELF	SSW22BX23B	SSW22BX23B	NASHVILLE	8	EA
40	27" SECONDARY BREAKER STRIP	HXBS27	20-0100	JEANS	6	EA
41	48" SECONDARY BREAKER STRIP	HXBS48	20-6910	JEANS	4	EA
42	BREAKER STRIP CORNER	HXBSC01	19-0000	JEANS	16	EA
43	36" SHELF STANDARD	HXSD36	006500736	KASON	6	EA
44	SMALL HEATER WIRE	L1HR90	64-200	RHS	2	EA
45	TERMINAL BLOCK, 8-POLE	PCBS03*	MARATHON #208	MG	1	EA
46	RELAY, 30 AMP	PCCR64*	886-0144	ALLIED	1	EA
47	LIGHT SWITCH	LRLS01W	67F1621	NEWARK	4	EA
48	LIGHT FIXTURE	LRLF01	L20-1010-GS	COMPONENT HDW	1	EA
49	LIGHT BULB, 115V, 40W	LRSB01	685206	BARNETT	1	EA
50	SMALL DOOR ASSEMBLY	D2(FRC)	D2(FRC)	COSPOLICH	2	EA
51	SMALL DOOR GASKET	G22X23MV	6449	TRG	2	EA
52	65" SECONDARY BREAKER STRIP	HXBS65	20-0090	KASON	2	EA
53	LARGE HEATER WIRE	L1HR104	64-200	RHS	2	EA
54	GRILL WITH CUT OUTS FOR ELECTRONIC CONTROLS	GR05-EC(FRC) (REV. 001)	GR05-EC(FRC) (REV. 001)	COSPOLICH	1	EA

***Not shown in illustrations**

****Optional accessory**

Illustrations 7.A, 7.B—RUT520-2-PM, Condensing Unit Assembly (15)

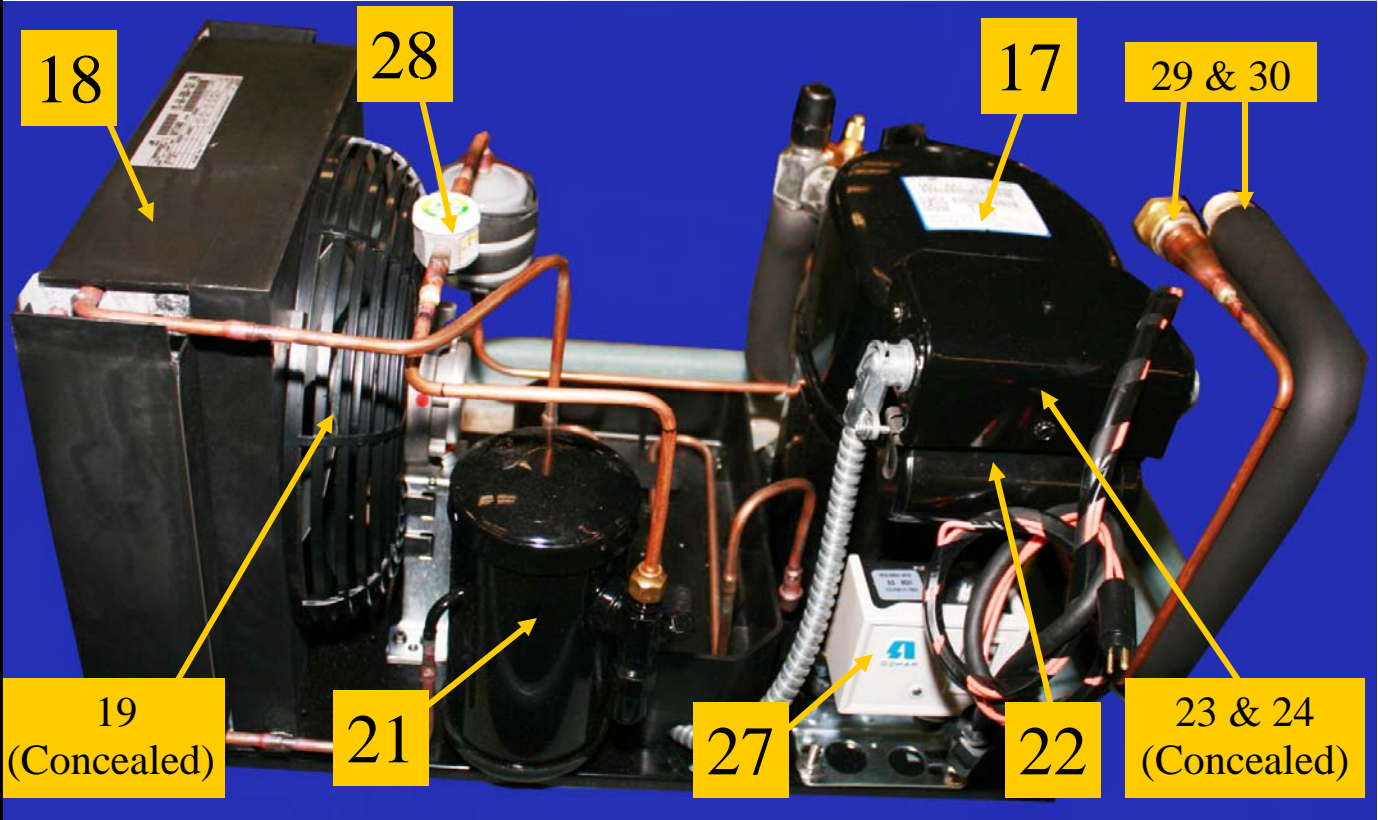

Illustration 7.A

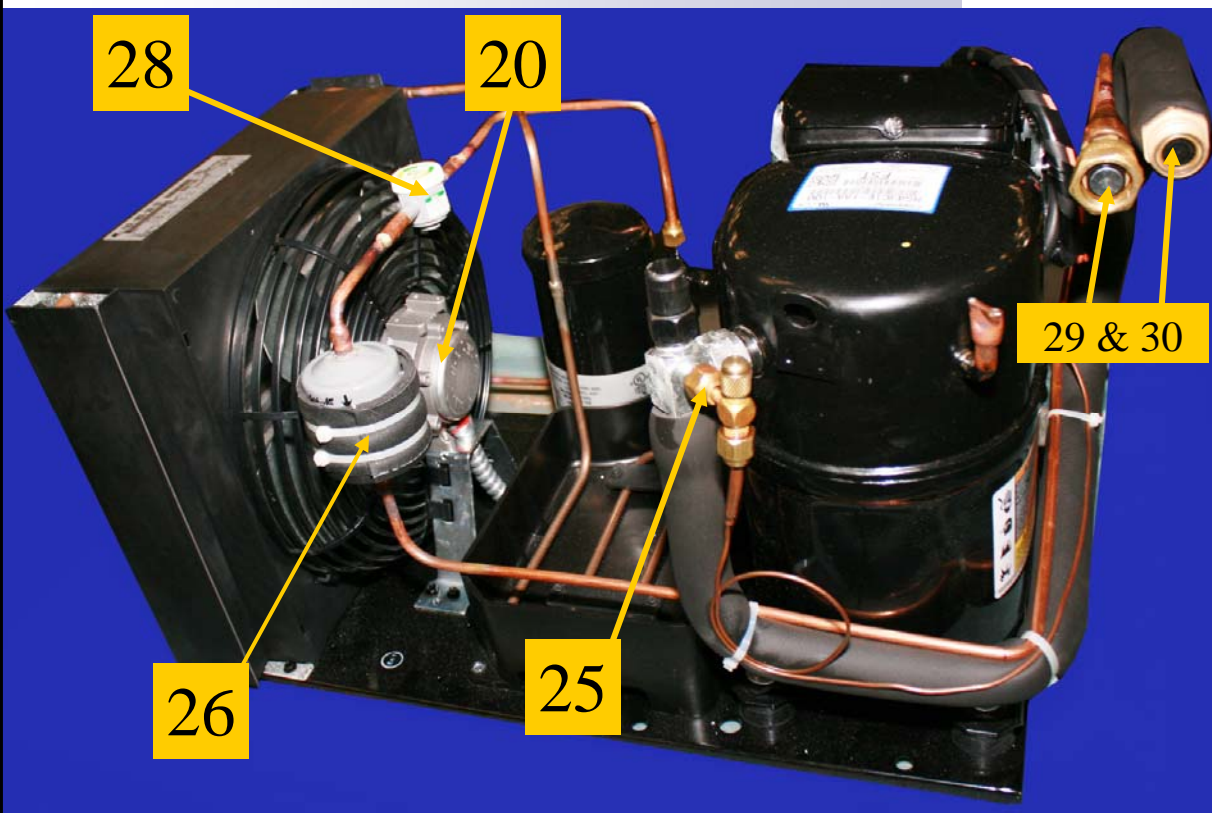

Illustration 7.B

Illustration 7.C, 7.D, 7.E – RWE040-PM, Evaporator Coil Assembly (31)

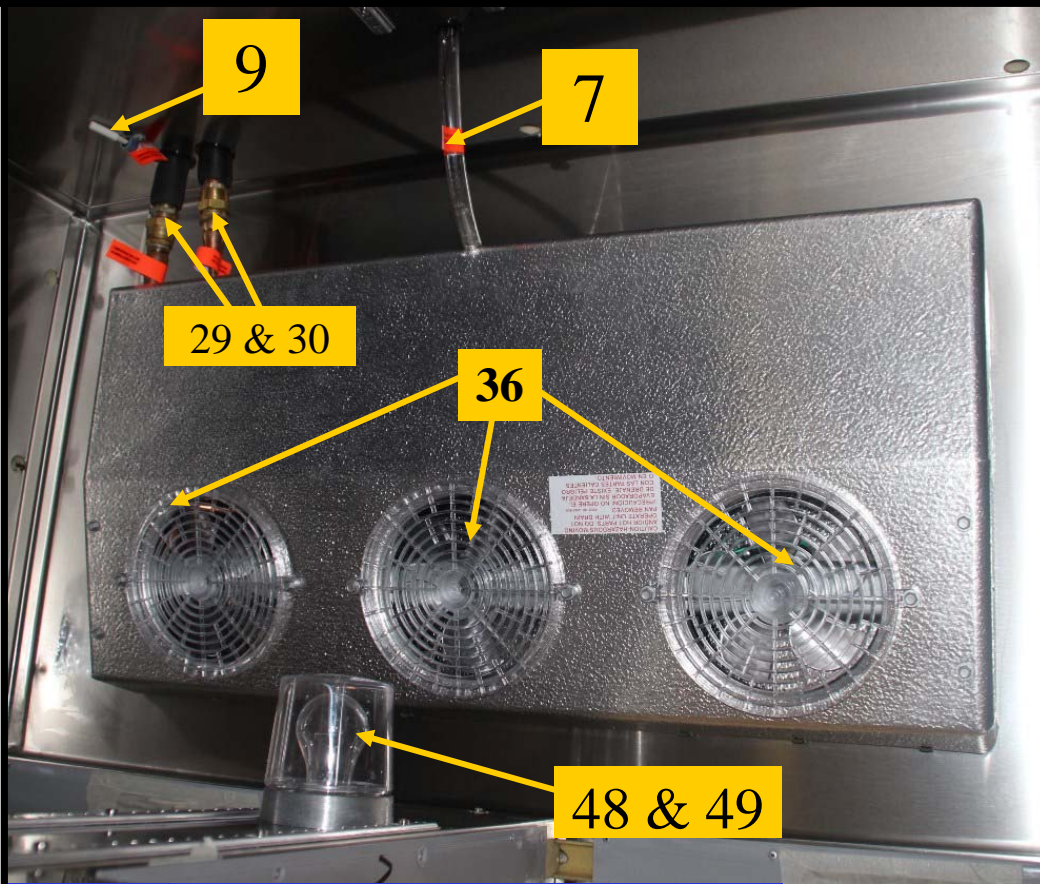

Illustration 7.C

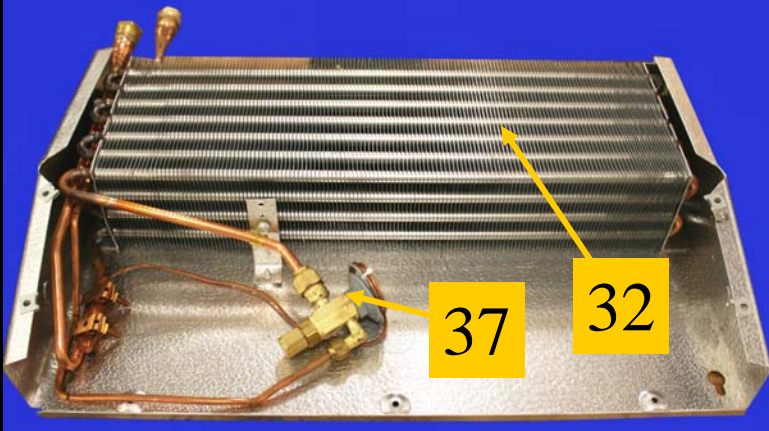

Illustration 7.D

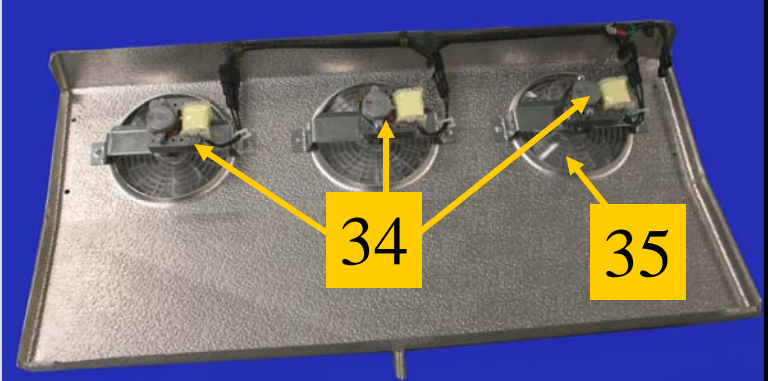

Illustration 7.E

Illustrations 7.F, 7.G – RWTT65-PM(L), Electronic Controller Assembly (14)

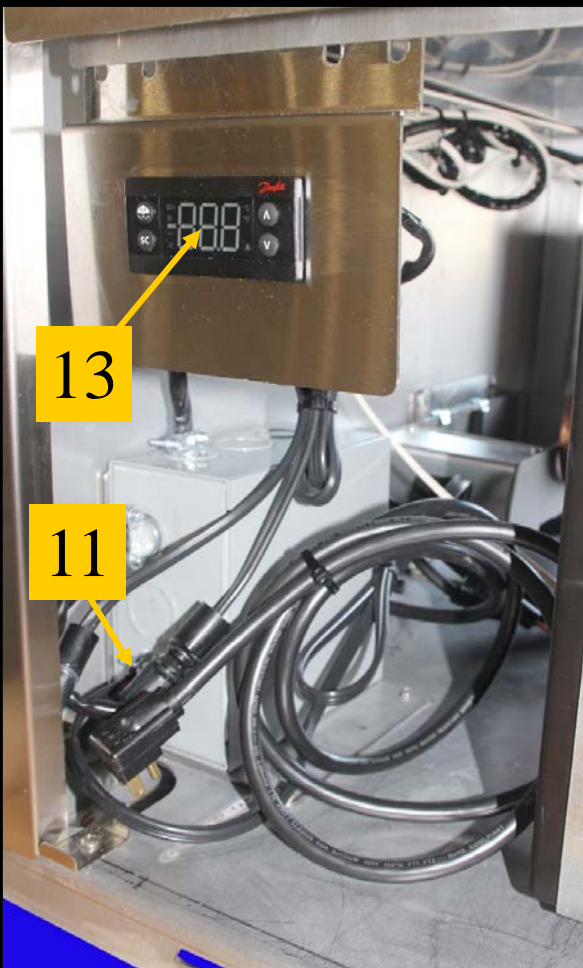
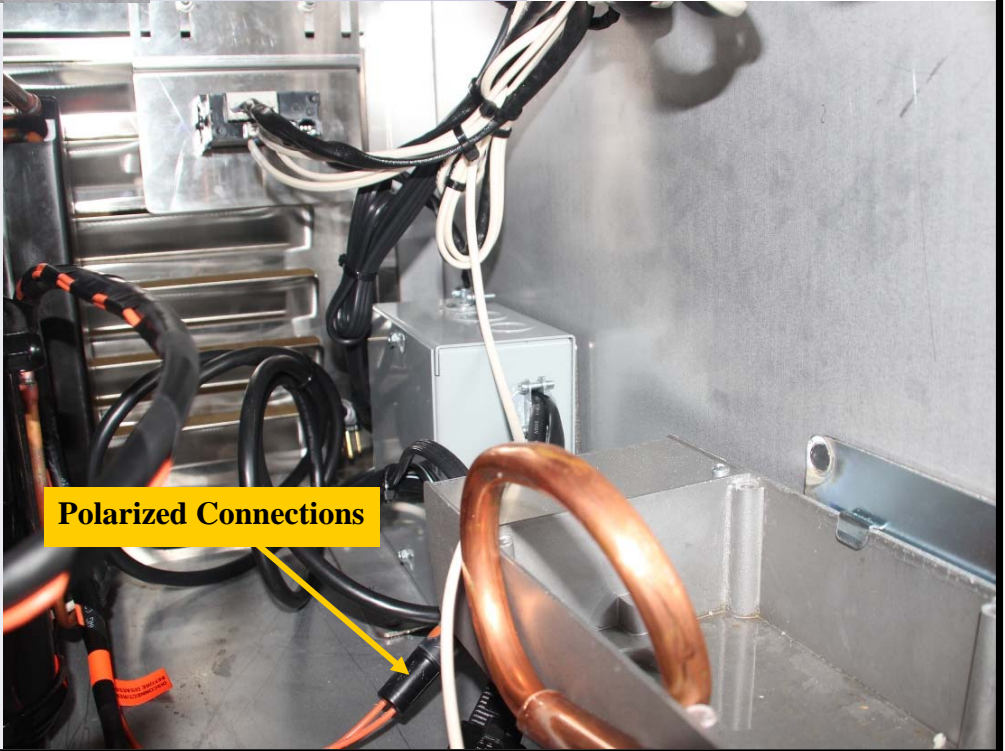

Illustration 7.F



Illustration 7.G



Illustrations 7.H, 7.I, 7.J, 7.K – Door Detail

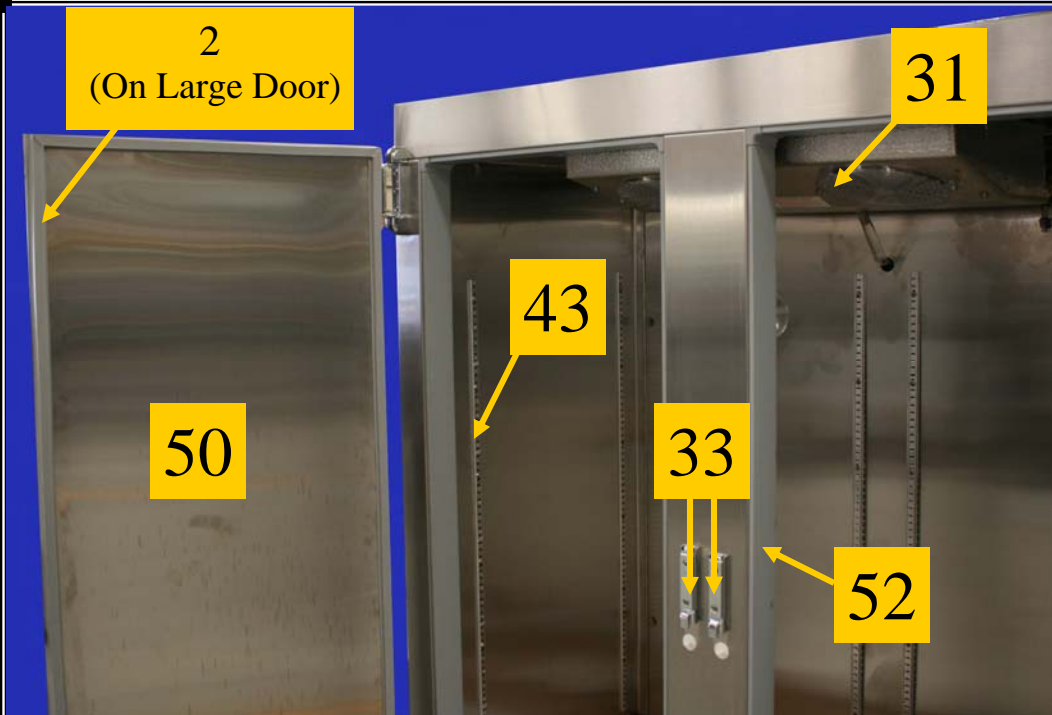

Illustration 7.H

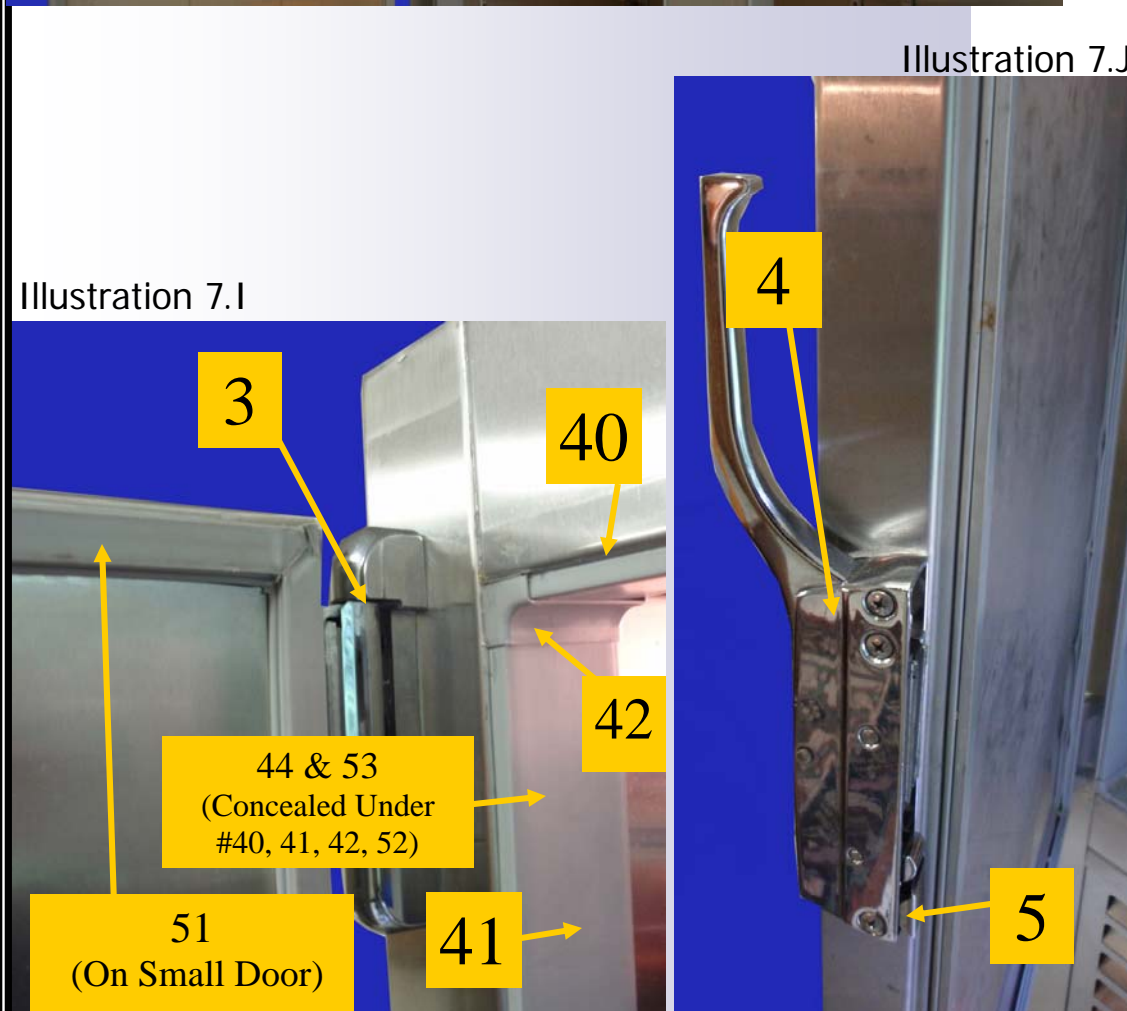

Illustration 7.J

Illustration 7.K



Illustration 7.L – Interior Detail

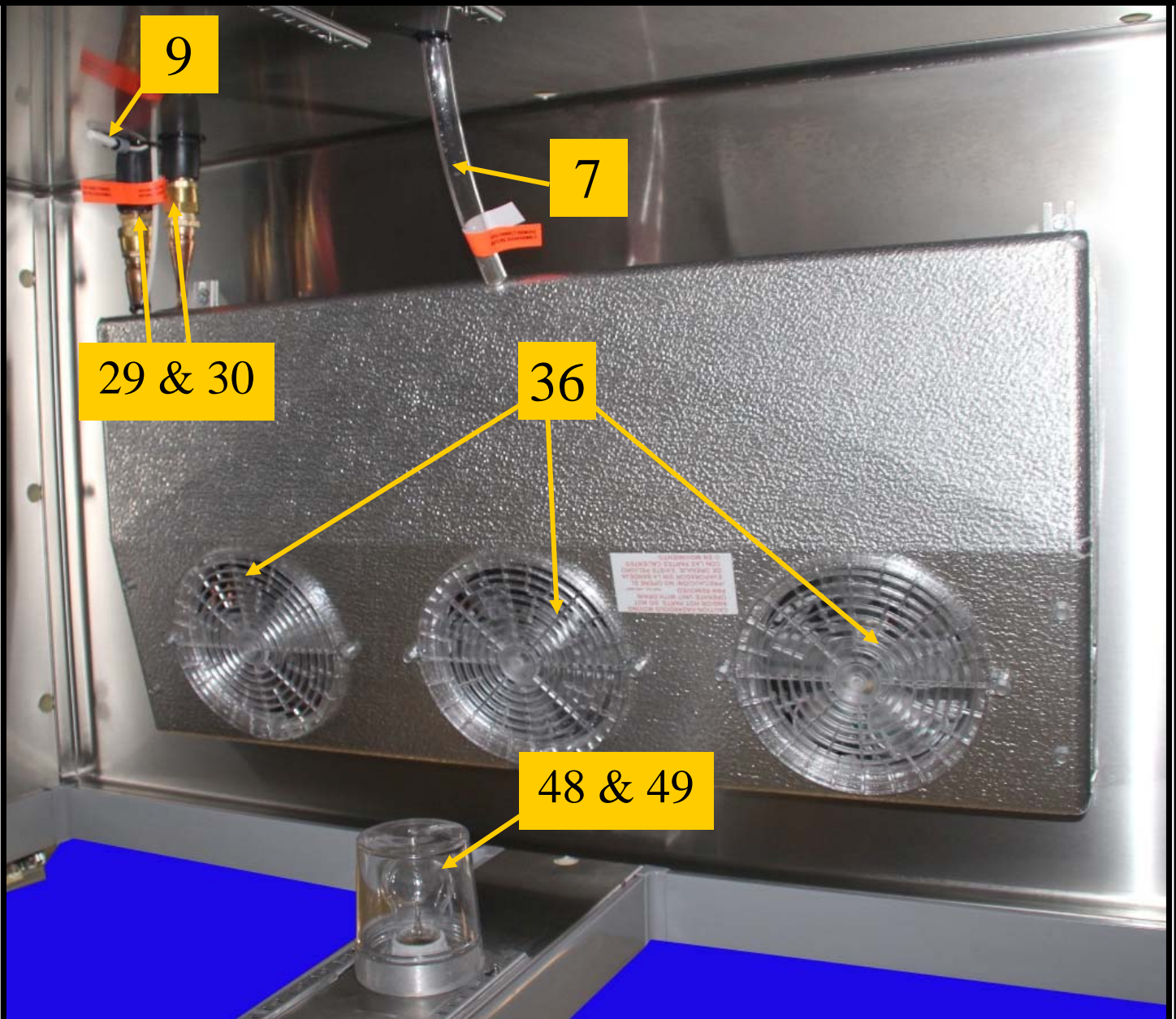

Illustration
7.L

Illustrations 7.M, 7.N, 7.O, 7.P—Main Unit Front/Rear Detail & Accessories



Illustration 7.M



Illustration 7.N



Illustration 7.P



Illustration 7.O

Chapter 8 – Installation

8.1 Unpacking

Note: Before unpacking unit, note any crating markings and check for damage to crating and notify the carrier if there should appear to be damage to the equipment.

The unit is shipped from the factory securely fastened to a single shipping pallet protected by an external wrapping.

1. Carefully remove all external wrappings and other protective coverings.
2. Review the installation section of the manual completely prior to installing.
3. Discard crating materials.

8.2 Installation

1. Before moving the unit to the installation site, double-check passageways to make certain that it will move through without modifications.

Note: In certain instances, it may be necessary to remove the doors and hardware to negotiate tight spaces.

2. On most shipboard applications, a permanent base is fabricated by the ship builder to accommodate the base frame of the unit. If required Cospolich can furnish a foundation which can be attached to the deck. **Note:** Not required on units with legs.
3. Once the cabinet has been attached to the ship's foundation, it is necessary to apply a silicone sealant around the complete perimeter at the point that the cabinet base contacts the foundation. **Note:** Not required on units with legs.
4. Position the unit to allow sufficient ventilation, usually leave a 3" clearance from adjacent bulkheads and other equipment.
5. Level the cabinet from front to back and from side to side. This is important so that when securing to the deck base, the cabinet will not be pulled out of square.
6. Before applying electrical power to the unit, you should first check the electrical characteristics of the appliance and make certain that they agree with those of the electrical supply source. **CAUTION: LOW OR EXCESSIVE VOLTAGE CAN SEVERELY DAMAGE THE ELECTRICAL SYSTEM.**

Chapter 9 – Modular Installation

9.1 Introduction

By design the modular version of the R41-2M-SN-MLR(FRC) refrigerator has been engineered and manufactured to be disassembled and reassembled aboard ship. By following these instructions you can be guaranteed a successful installation. Should questions arise or assistance become necessary, please call Cospolich customer service at (800) 423-7761 or (985) 725-0222. Email at Cospolich@cospolich.com.

9.2 Installation Skill Level

In general, the skill level of the installer should be of a journeyman class in the area of mechanic. The primary process will require the following written instructions, use of common tools, and the proper fitting and alignment of the components. The electrical portion of the installation will be minimal, only requiring the unit to be plugged in and all electrical voltages verified.

9.3 Tools

A special wrench was furnished with the cabinet which is needed to operate the camlocks used in the assembly of the equipment. Other common tools required are standard/Phillips screwdrivers and wrenches. If the equipment is to be attached to a foundation, it may be necessary to drill holes.

9.4 Primary Components

Bottom with Condensing Unit/Controls Compartment/Base, Left End, Right End, Left Rear/Back, Right Rear/Back, Top, Evaporator Coil Assembly, Condensing Unit Assembly, Control Panel Assembly, 2 ea Small Doors, 2 ea Large Doors, Front Vertical Mullion, Front Grill.

9.5 Disassembly

1. Remove the 4 ea doors.
2. On the interior of the unit, remove the screws holding the evaporator coil drain line cover in place, then remove the stainless steel drain line cover.
3. Remove the 4 ea screws holding the exterior housing cover in place on the evaporator coil assembly. Remove the outer evaporator coil housing cover. 36

Chapter 9 – Modular Installation

4. Remove the cabinet sensor bulb & cover from the rear wall/back of the unit.
5. Disconnect the modular quick connect refrigeration fittings to the evaporator coil assembly.
6. Loosen/remove the 2 ea screws holding the rear of the evaporator coil assembly to the top of the unit. Loosen/remove the 3 ea zip screws holding the front of the evaporator coil assembly to the top of the unit. Remove the evaporator coil assembly.
7. Remove the 2 ea rear tubing covers on the exterior back of the cabinet.
8. Pull/remove the cabinet sensor bulb and cover through the refrigeration holes to the exterior back of the cabinet.
9. Remove the front louvered grill.
10. Unbolt the 2 ea bolts to the condensing unit assembly using a 3/8" nut driver. Slide out the condensing unit assembly. Disconnect both the electrical and refrigeration quick connect fittings. Remove the condensing unit assembly.
11. Disconnect all polarized connections at the control panel assembly adjacent to the condensing unit assembly. **NOTE:** *It is not necessary to remove the electronic controller assembly.*
12. Using the camlock wrench provided, loosen all perimeter camlocks around the top panel. Lift and remove the top panel.
13. Loosen camlock to from front vertical mullion. Remove mullion.
14. Loosen all perimeter camlocks securing the left end panel. Remove the left end panel.
15. Loosen all perimeter camlocks securing the back/rear panels. Remove the back/rear panels.
16. Loosen all perimeter camlocks securing the right end panel. Remove the right end panel.

Chapter 9 – Modular Installation

17. Reverse the process to properly assemble and install the unit.
18. During installation, prior to installation of the door, the anti-condensate perimeter mullion heater must be installed around the door perimeters adjacent to the primary breaker strips. The secondary breaker strips and breaker strip corners must then be installed over the primary breaker strips. Finally, Install all hinge covers.

NOTE: *When reassembling the unit on site, all panels must be sealed with beads of gray food-grade silicone (provided) in all female joints. This ensures a proper seal between panels and prevents air, heat, and liquid infiltration. Gray plugs must also be in place in all camlock holes when sealing the unit prior to initial use. A squirt of silicone in each camlock hole is also recommended for a proper seal. After all panels are assembled, silicone all interior and exterior seams for a final seal.*

Chapter 10 – Electrical and Mechanical

10.1 Introduction

This section of the manual contains drawings and schematics of the electrical and piping systems.

Illustration 10.A – Mechanical Piping Diagram

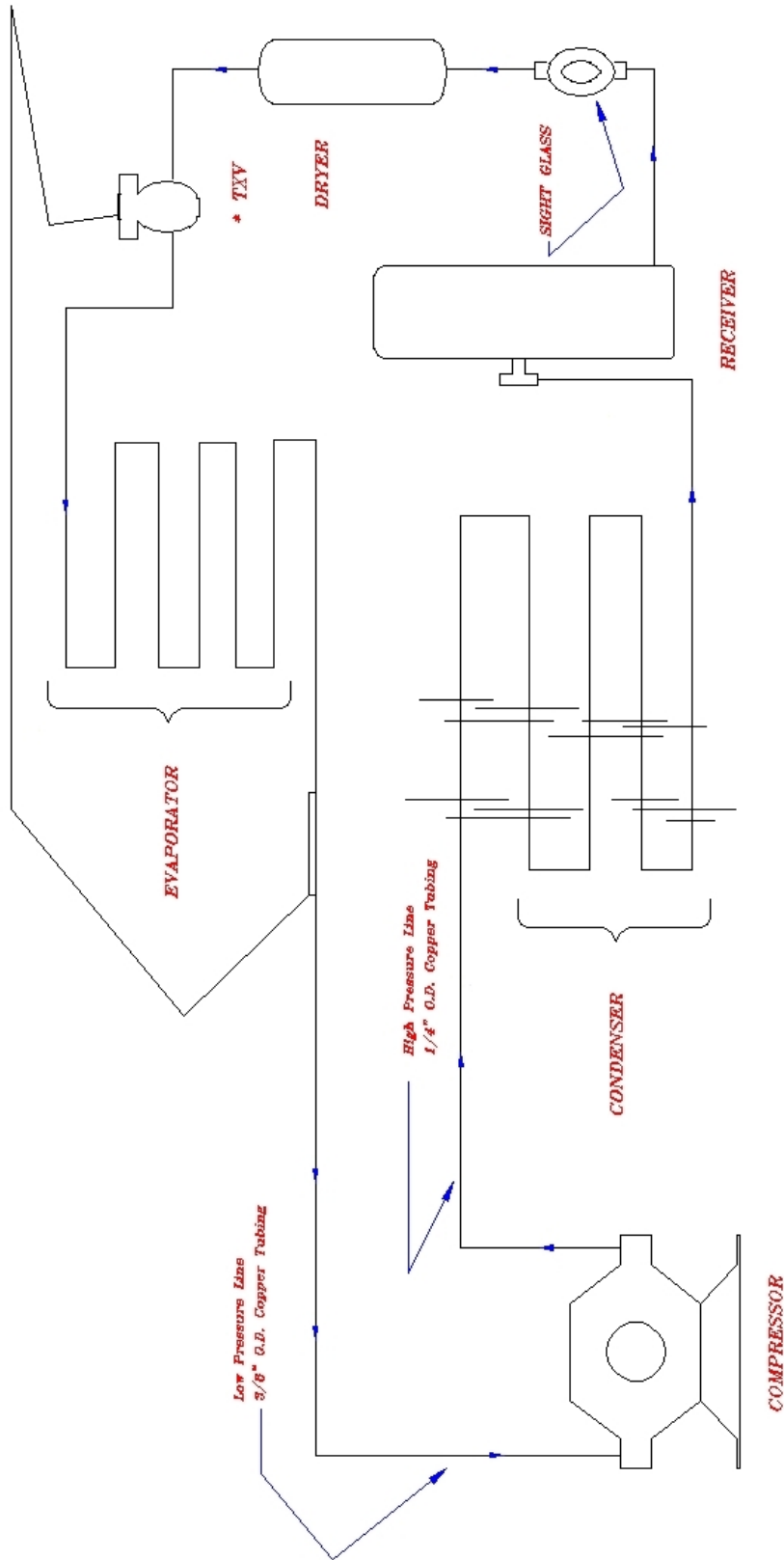

* THERMOSTATIC EXPANSION VALVE

ITEM REFRIGERATION PIPING SCHEMATIC	
PROJECT STANDARD-REFRIGERATOR OF FREEZER	DWG # 70033
DATE 06-10-96	SCALE N.T.S.
DRAWN BY EPL	
CORPORATION	
REFRIGERATOR CO., INC. NORCO, LOUISIANA	

Illustration 10.B – Electrical Schematic (Electronic Controller)

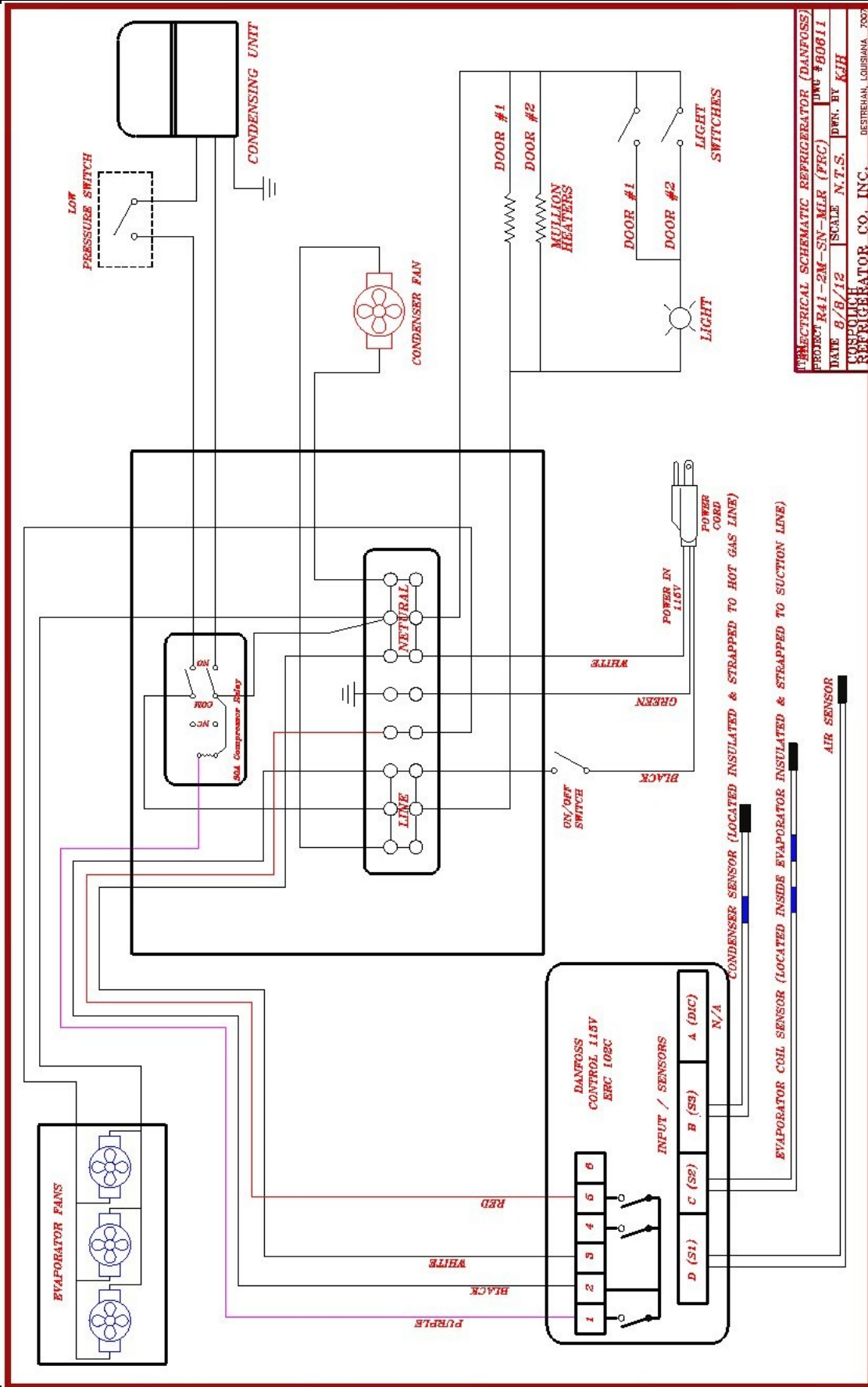

ELECTRICAL SCHEMATIC REFRIGERATOR (DANFOSS)
 PROJECT R41-2M-SN-MLR (FRC) DWG #80611
 DATE 8/8/12 SCALE N.T.S. DWN. BY KJH
 REFRIGERATOR CO., INC. BOSTON, MASSACHUSETTS

Chapter 11 – Limited Warranty

Cospolich Inc. warrants their cabinets to consumers against defects in material or workmanship under normal use and service for a period of one year from the date of the shipment. We will repair or replace at our option, any part, assembly or portion thereof which Cospolich's examination discloses to be defective. Cospolich will pay the labor costs for the repair up to twelve (12) months from date of shipment.

In instances where the purchaser is not the owner in possession and the acceptance of Cospolich equipment is closely tied to the completion and delivery of the project, our warranty will begin on the acceptance date and will extend for one year.

Terms

Exclusions

Cospolich's obligations under this warranty shall not extend to any malfunction or other problem caused by unreasonable use, such as but not limited to, improper setting of controls, improper installation, improper voltage supply, loose electrical connections or blown fuses, and damage not attributable to a defect in workmanship. This warranty shall not apply to any cabinet or component part that has been suspect to any accident, alteration, abuse, misuse to any damage caused in fire, flood, or other acts of God and to any product that has been serviced by an unauthorized service person or company.

To secure Warranty Service

If you claim a defect under this warranty, direct your claim to whom you purchased the product, giving model, serial and code numbers with a description of the problem. Telephone calls should be directed to the service department at (800) 423-7761 or (985)725-0222 with fax request going to (985) 725-1564.

If the above procedure fails to satisfy your claim, you may write directly to the following address including the above identifying information.

**DIRECTOR of CUSTOMER RELATIONS
COSPOLICH INC.
P.O. BOX 1206
DESTREHAN, LA 70047**

There is not other express warranty on the Cospolich units except the terms stated herein. Any implied warrants of fitness and merchantability are limited in duration to the duration of this Warranty. The liabilities of Cospolich are limited solely and exclusively to replacement as stated herein and do not include any liability for any incidental, consequential or other damages of any kind whatsoever, whether any claim is based upon theories of contract negligence or tort. Some states do not allow limitations on how long an implied warranty lasts, or the exclusion of limitations of incidental or consequential damages. So the above limitations and exclusions may not apply to you. This warranty gives you specific legal rights and you may also have other rights that vary from state to state.

Appendix 1 – Revision History

CHG NO.	DATE	DESCRIPTION OF CHANGE	CHG. BY	APP BY