



Shipboard Modular Flexible Serving Line

Technical Manual

Installation, Operation, and Maintenance Instructions

Models:

FSL6T-2M-SN-MLR



Table of Contents

<p>List of Illustrations..... 3</p> <p>List of Tables..... 4</p> <p>Chapter 1 General Information..... 5-8</p> <p> 1.1 Introduction..... 5</p> <p> 1.2 Scope..... 5</p> <p> 1.3 Equipment Description..... 5</p> <p> 1.4 Equipment Supplied..... 5</p> <p> Table A Leading Particulars..... 6</p> <p> Illustrations 1.A—1.B..... 7-8</p> <p>Chapter 2 Operation..... 9</p> <p> 2.1 Introduction..... 9</p> <p> 2.2 Controls and Indicators..... 9</p> <p> Table B Controls and Indicators..... 9</p> <p> Illustrations 2.A—2B..... 10</p> <p> 2.3 Start-up Procedure..... 11</p> <p> Table C Start-up Procedure..... 11</p> <p> 2.4 Dual Serving Module Operating Instructions Illustrations 2.C—2.D..... 12</p> <p> 2.5 Shutdown Procedure..... 13</p> <p> Table D Shut Down Procedures..... 13</p> <p> 2.6 Cleaning Instructions..... 14</p> <p> 2.7 Extended Period Inactivity..... 14</p> <p> Table E Shutdown for Extended Period..... 14</p> <p>Chapter 3 Functional Description..... 15</p> <p> 3.1 System Description..... 15</p> <p> 3.2 System Operation..... 15</p> <p>Chapter 4 Scheduled Maintenance..... 16-18</p> <p> 4.1 Introduction..... 16</p> <p> 4.2 Preventive Maintenance Index..... 16</p> <p> 4.3 Preparation for Maintenance..... 16</p> <p> 4.4 Maintenance Procedures..... 16</p> <p> A. Monthly Maintenance Requirements.. 16</p> <p> B. Bi-Monthly Maintenance Requirements 17</p> <p> C. Annual Maintenance Requirements.. 17</p> <p> D. 3-Year Maintenance Requirements.. 17</p> <p> Table F Preventive Maintenance..... 18</p> <p>Chapter 5 Troubleshooting..... 19</p> <p> Table G Mechanical & Electrical..... 19</p>	<p>Chapter 6 Parts List..... 20</p> <p> 6.1 Introduction..... 20</p> <p> 6.2 Source Codes..... 20</p> <p> Table H Source Codes..... 20</p> <p> Table I Parts List FSL6T-2M-SN-MLR..... 21</p> <p> Illustrations 6.A—6.B Controls & Electrical 22</p> <p> Illustrations 6.C—6.D Breaker Box Assembly 23</p> <p> Illustrations 6.E—6.F Distribution Block Assembly 24</p> <p> Illustrations 6.G—6.H Cabinet & Door Detail 25</p> <p> Illustrations 6.I—6.J Dual Serving Module 26</p> <p> Illustrations 6.K—6.L Main Unit Front/Rear 27</p> <p>Chapter 7 Installation..... 28</p> <p> 7.1 Unpacking..... 28</p> <p> 7.2 Installation..... 28</p> <p>Chapter 8 Modular Installation..... 29</p> <p> 8.1 Introduction..... 29</p> <p> 8.2 Installation. Skill Level..... 29</p> <p> 8.3 Tools..... 29</p> <p> 8.4 Disassembly..... 29</p> <p>Chapter 9 Electrical & Mechanical..... 30-32</p> <p> 9.1 Introduction..... 30</p> <p> Illustrations 9.A—9.B..... 31-32</p> <p>Chapter 10 Warranty..... 33</p>
---	---

List of Illustrations

Illustration	Title	Pg.
1.A	General Arrangement Drawing — FSL6T-2M-SN-MLR	7
1.B	Isometric Drawing-Dual Flex Module	8
2.A	Dual Serving Module On/Off/Mode Controller	10
2.B	Breaker Box, Distribution Block Assembly, & Rear Distribution Panel	10
2.C	Dual Serving Module Docked in Flex Serving Line Cabinet	12
2.D	Dual Serving Module Plugged Into Rear Distribution Panel	12
6.A	Distribution Block Assembly, Breaker Box, & Rear Distribution Panel	22
6.B	Rear Distribution Panel Detail	22
6.C	Breaker Box Exterior Detail	23
6.D	Breaker Box Interior Detail	23
6.E	Distribution Block Assembly Exterior Detail	24
6.F	Distribution Block Assembly Interior Detail	24
6.G	Interior Door Detail	25
6.H	Latch Detail	25
6.I	Dual Serving Module Front Detail	26
6.J	Dual Serving Module Rear Detail	26
6.K	Flexible Serving Line Main Unit Front Detail	27
6.L	Flexible Serving Line Main Unit Rear Detail	27
9.A	Electrical Schematic—Cabinet	31
9.B	Electrical Schematic—Dual Serving Module	32

List of Tables

Table	Title	Page
A.	Leading Particulars	6
B.	Controls and Indicators	9
C.	Start-Up Procedures	11
D.	Shutdown Procedures	13
E.	Shutdown Procedures for Extended Periods	14
F.	Preventive Maintenance	18
G.	Mechanical and Electrical Troubleshooting Guide	19
H.	Source Codes	20
I.	Parts List - FSL6T-2M-SN-MLR	21

Chapter 1 – General Information

1.1 Introduction

This technical manual provides information on the installation, operation, maintenance, and inspection of this unit manufactured by **Cospolich Inc.**, Destrehan, Louisiana. A complete parts breakdown is provided in Chapter 7.

1.2 Scope of the Manual

This technical manual provides information for installation, operating, preventative maintenance, and service instructions, including applicable drawings and figures of the equipment.

1.3 Equipment Description

The unit consists of the following parts:

- A. Storage Compartment - The storage compartment is clear storage area.
- B. Door(s)- Access to the storage compartment is through hinge-mounted door(s).
- C. Flex Serving Modules—The flex serving modules are located on the top of the cabinet. Each well is self-contained, removable, and has its own individual on/off/mode control switch.
- D. Cabinet - The cabinet is the enclosure in which all of the above items are housed.
- E. Control Panel Assembly—The control panel assembly is located inside the cabinet on one end and is contained inside of two NEMA-4 plastic control boxes, one for the breakers and one for the distribution block.

1.4 Equipment Supplied

The unit is shipped from the factory fully assembled, palletized and crated to minimize the possibility of damage in shipping and storage.

Table A – Leading Particulars

MANUFACTURER:	Cospolich Inc. Destrehan, Louisiana 70047
TYPE:	Shipboard Modular Flexible Serving Line <div style="border: 1px solid black; padding: 5px; width: fit-content; margin: 10px auto;">FSL6T-2M-SN-MLR</div>
PURPOSE:	Hot/Cold Holding/Serving of Food Items/ Perishables
ELECTRICAL REQUIREMENTS: (Per Module)	Breaker Required: 15 Amp
CHILL MODE: (Per Module)	Power Supply - 115 Volt AC, 60 Hz, 1 Phase Amp draw - Maximum Power Demand: 2 Amps Watts - 230 Watts
HEAT MODE: (Per Module)	Power Supply - 115 Volt AC, 60 Hz, 1 Phase Amp draw - Maximum Power Demand: 7.2 Amps Watts - 900 Watts
REFRIGERANT:	134A
DRAIN:	Not Required
DIMENSIONS:	116" WIDE X 29" LONG X 30" HIGH

Illustration 1.A—General Arrangement Drawing

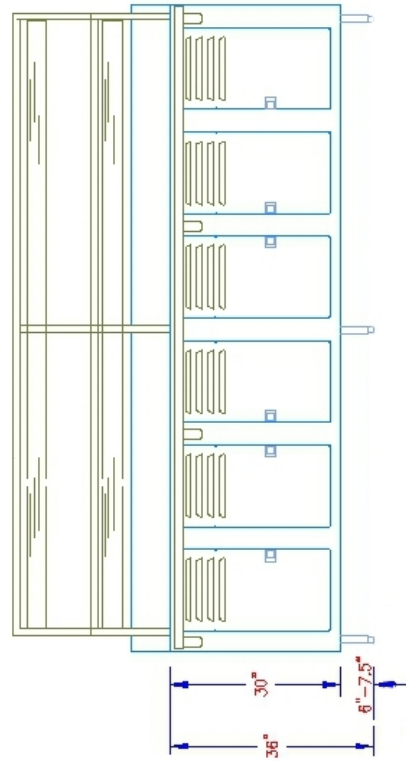
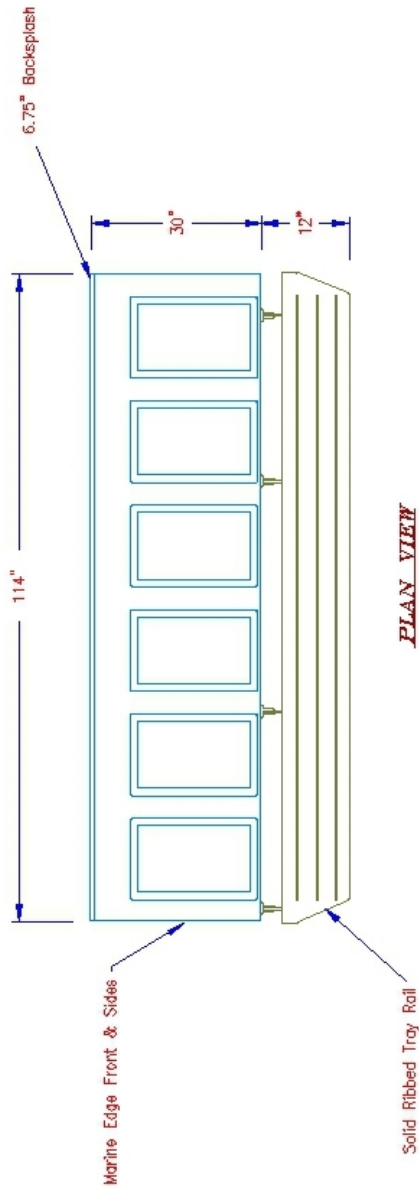

REVISIONS:

ITEM MODEL: FSL67-2M-SN-MLR SERVING LINE	
PROJECT	DWG # 92467
USS GEORGE H.W. BUSH (CVN77)	REV.
DATE 12-27-10 SCALE	DOWN BY CW
COSPOLICH INC.	
NORCO, LOUISIANA	

Fabrication can proceed according to these specifications, except as noted:

Approved By: _____

Date: _____

Illustration 1.B—Isometric Drawing-Dual Flex Module

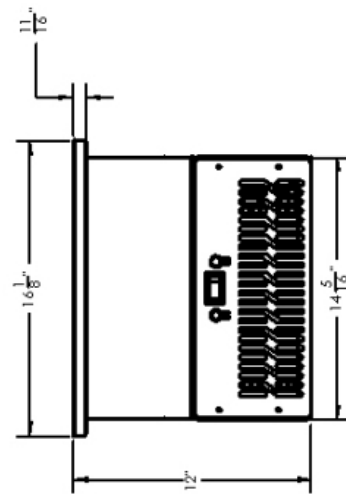
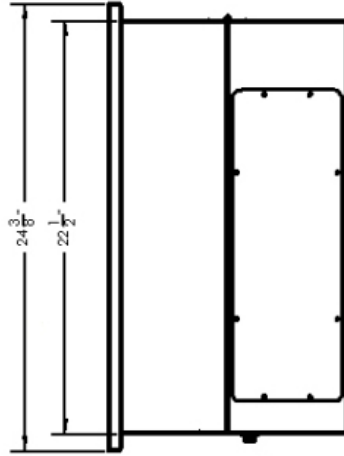
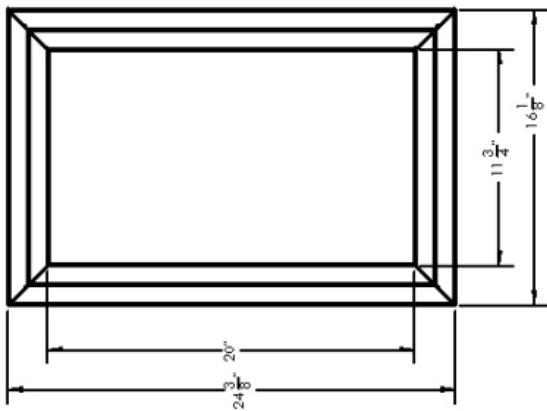
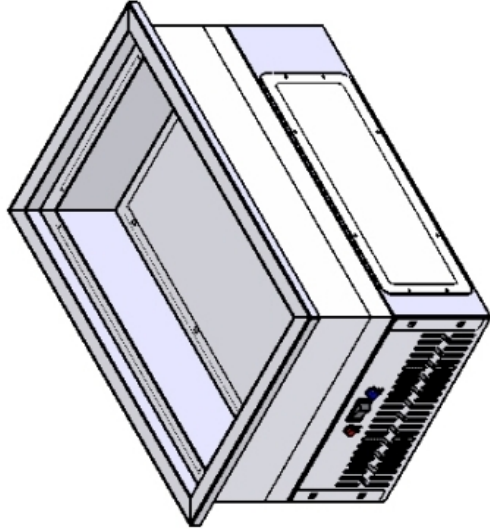

ITEM: DSFM 02	Process: Presentation
PROJECT: Dual Service Food Module	DWG # DSFM PR_01
DATE: 2/9/2011	SCALE: 1:6
BY: JLS	BY: JLS
NORCO, LOUISIANA	
SHEET 1 of 1	

This drawing and all information contained on it are proprietary to Cospolich Inc. and cannot be released, reproduced or otherwise misused without the written approval of Cospolich Inc.

Chapter 2 – Operation

2.1 Introduction

This model is a heavy-duty pieces of food service equipment designed for intermittent use. Each individual serving module incorporates electronic controls to regulate the cycling of the heated/chilled wells.

2.2 Table B—Controls and Indicators

Name	Type	Function
On/Off/Mode Switch (Part of Dual Serving Module)	Toggle Switch	Power Control, terminates all electrical into and past the supply cord, switches module mode from hot to off to cold depending on need
Electronic Controller (Part of Dual Serving Module)	Push Button Electronic	Cycles heating element and controls temperature
Electrical Breaker	Electrical Interrupt	Breaks/Connect power to main circuit

Illustrations 2.A-2.B Controls, Indicators, & Electrical



Illustration 2.A-
Dual Serving Module
On/Off/Mode Switch

Illustration 2.B-
Breaker Box, Distribution Block Box,
Rear Distribution Panel



2.3 Start-Up Procedures

The system is completely factory assembled and ready for operation. To energize the system, it is only necessary to find the power supply cord and connect it to a proper 115V power source. Once the supply cord has been connected to a power source, the unit can be started by first checking that all breakers are in the proper position. Each module can be set to the desired mode (Heat/Off/Chill) by flipping the power control toggle switch to the appropriate position.

Note: On modular units (MLR suffix in model number) the equipment will require dismantling.

Table C – Start-Up Procedure

	Operation	Results
1.	Activate system by connecting electrical service cord to power supply.	This brings power to the control.
2.	Check all breakers inside the breaker box are in the correct "ON" position	This brings power to the controls.
3.	Place power switch to "Heat/Off/Chill" position	The heating element or compressor will become energized

2.4 Dual Serving Module Operating Instructions

1. Dual serving modules (DFM-N) can be placed individually into the six (6) ports of the flex serving line cabinet.
2. Once placed into the cabinet, the power cord for each module must be plugged into the corresponding outlet along the rear distribution panel inside the cabinet.
3. The front door can then be closed to each individual port.
4. In order to energize the entire cabinet and all the docked dual serving modules, all the breakers contained within the large control panel box on the inner left wall of the cabinet must be in the "ON" position. Each well can individually controlled from this breaker panel.
5. Operation of each dual serving module is explained in further detail in the "DFM-N Dual Serving Module" Technical Manual.

Illustration 2.C-
Dual Serving Module Docked in Flex
Serving Line Cabinet



Illustration 2.D-
Dual Serving Module Power Cord
Plugged into Rear Distribution Panel of
Flex Serving Line Cabinet



2.5 Shut Down Procedure for Short Term

- To shut down, turn the power switch for each module to the center "OFF" position.

Table D – Shut-Down Procedure

	Operation	Results
1.	De-energize the system by flipping the power control switch to the center "OFF" position.	Once the system is de-energized the cabinet has no power and the modules will no longer operate.



WARNING: PRIOR TO CLEANING ANY OF THE UNIT, THE SYSTEM SHOULD BE DEACTIVATED BY DISCONNECTING THE POWER SUPPLY.

2.6 Cleaning Instructions

NOTE: Cleaning is the most important thing that can be done to ensure optimum performance and reliability from the Flex Serving Line Unit. All accessible stainless steel surfaces should be cleaned after every use.

1. It is necessary that the power source be turned off..
2. Remove all insets, pans, and/or inserts.
3. Wipe entire unit using a clean cloth or sponge with a mild detergent.



WARNING: DO NOT SPLASH OR POUR WATER ONTO THE EVAPORATOR ASSEMBLY, CONTROL PANEL, CONDENSING UNIT AND/OR WIRING.

CAUTION: POSSIBLE SHOCK HAZARD MAY RESULT AND UNIT MAY BE DAMAGED SHOULD ELECTRICAL COMPONENTS BECOME WET.

4. The controls should be free of moisture, dust, debris, grease, etc. at all times.
5. A plastic scouring pad may be used in the well to remove any hardened food particles.

7. When cleaning is completed, rinse the well thoroughly with a solution of vinegar and water to neutralize all detergent/cleaner residue.

Important: It is not recommended to use any strong or caustic cleaners on the Flex Serving Line. Do not allow ammonia to stand in the interior of the unit. Make certain to rinse thoroughly to remove all residue. Failing to do so may cause damage or corrosion to the unit.

2.7 Preparation for an Extended Period of Inactivity

-This unit is designed for periodic use. For extended shut down the electrical should be disconnected and the interior cleaned.

Table E – Shut-Down Procedure for Extended Period

	Operation	Results
1.	Disconnect Power Supply	De-energizes entire unit
2.	Clean all modules	Follow cleaning instructions
3.	Clean and wipe dry the storage compartment	Will reduce any odor build-up during shut-down

Chapter 3 – Functional Description

3.1 System Description

The unit is a self-contained, automatically controlled, continuous duty hot/cold food serving system. It is designed with the intent and purpose of holding and serving hot/cold food items and functioning as a working surface from which hot/cold foods may be prepared and served.

The flex serving modules are each individually controlled and may be set in either a "Heat" or "Chill" Mode.

The equipment is comprised of the following two basic compartment assemblies:

1. Dual Serving Modules—These are the individual warming/chilling compartments on the top of the service counter.
2. Storage Compartment—This area is open storage space for dry goods and general storage. It also contains the electrical breaker box, terminal box, and rear power distribution panel.

3.2 System Operation

The design of the flex serving line focuses primarily on the safe storage of food while waiting to be served. In its engineering, considerable attention was placed on both its function as well as its serviceability.

The system is a pre-wired, closed-loop system with removable individual dual serving modules.

Chapter 4—Scheduled Maintenance

4.1 Introduction

To insure the longest and most trouble free operation, a thorough periodic maintenance schedule is required. The maintenance system should be aimed at maximizing the efficient utilization of maintenance personnel, minimizing down time, and providing the orderly acquisition of spare parts support.

The Cospolich Flex Serving Line will generally be in operation in a facility or on-board a vessel where scheduled maintenance is performed according to Maintenance Index Plans. This unit requires regular maintenance. This chapter is intended as an alternative to any standard maintenance program that may pre-exist. The preventative maintenance schedule is based upon similar maintenance requirements for commercial refrigeration equipment.

4.2 Preventive Maintenance Action Index

If there is not a maintenance index plan, we have formulated our schedule for periodic maintenance in Table F.

4.3 Preparation for Maintenance

Since many areas affected in the maintenance schedule are electrically supplies, it may be necessary to de-energize the system when making these inspections.

4.4 Maintenance

A. Monthly Maintenance

1. The unit should first be de-energized by switching the toggle switch for each module to the center "OFF" position. All six breakers in the breaker panel should then be moved to the "OFF" position.
2. Follow the cleaning instructions in Section 2.6 to clean each of the individual modules and the cabinet assembly.

B. Bi-Monthly Maintenance

1. Using a mild, non-abrasive detergent and water, wipe the cabinet exterior, paying careful attention to wipe the cabinet in the direction of the stainless steel grain texture.
2. Check the operation of each module to make certain they are performing accurately and adequately.

C. Annual Maintenance

1. Visually inspect the outer panels, doors, and other components of the cabinet. Check screws, mounting bolts, etc. to make certain they are tight and in place.
2. Inspect all electrical connections to make certain that there is a good contact and that wires are neither weak nor frayed.
3. Inspect the overall integrity of the cabinet.

D. Three Year Frequency Maintenance

1. Using a mild, non-abrasive detergent and water, wipe the cabinet exterior, paying careful attention to wipe the cabinet in the direction of the stainless steel grain texture.
2. Check the operation of each module to make certain they are performing accurately and adequately.
3. Inspect the operation of the door latch assemblies. Check for signs of wear, loose screws, or mechanical failure.
4. Inspect the operation of the door hinges.

Table F—Preventive Maintenance Action Index

	Frequency	Description
1.	Monthly	A. De-energize system and clean the modules.
2.	Bi-Monthly	A. Clean interior and exterior of cabinet with mild detergent and water, dry thoroughly B. Check the performance of the modules
3.	Annually	A. Visually inspect the outer panels and components of the cabinet B. Inspect electrical connections to make certain that there is a good contact and that wires are neither weakened or frayed. C. Check the integrity of the cabinet
4.	Three Year	A. Clean interior and exterior of cabinet with mild detergent and water, dry thoroughly B. Check the performance of the modules C. Inspect door latches and hinges.

Chapter 5 – Troubleshooting

This chapter will assist in a systematic check of components in determining any cause of equipment failure.

It will be necessary that the individual involved in the troubleshooting operation be familiar with the function of the equipment as described in Chapter 3.

The following table lists the most common symptoms that may be experienced and the recommended corrective action. The tables are separated into electrical maintenance, mechanical maintenance, and operators' actions.

Table G – Mechanical and Electrical Troubleshooting Guide

Symptom	Possible Failure	Remedy
Unit does not operate	A. Control failure B. Incorrect voltage C. Failed element D. Doesn't warm properly	A. Adjust control or replace B. Correct C. Replace D. Check electrical switch
Unit runs continuously	A. Control failure	A. Adjust control or replace

Chapter 6 – Parts List

6.1 Introduction

This section of the manual contains lists of replaceable parts. Each of the tables contain a list of removable parts associated with an assembly of the cabinet . No parts identification has been provided for details of permanently assembled items or those items that are not suitable for field repair.

6.2 Source Codes

The sources for some items are shown in the part tabulation. Where no individual source code is listed, the part is available through Cospolich Inc. , PO Box 1206, Destrehan, LA 70047 (Fed. Mfg. Code #66682).

Table H – Source Codes

Code Number	Name	Address
14852	Bohn Heat Transfer	Danville, IL 61932
32761	Kason Industries	Shenandoah, GA 30265
50992	Ranco Controls	St. Louis, MO 63143
78462	Sporlan Valve	St. Louis, MO 63143
14569	Copeland Corporation	Sidney, OH 45365
17529	Watsco	Hialeah, FL 33010
59431	Tecumseh Products	Tecumseh, MI 49286
49048	Miljoco Corporation	Eastpointe, MI 48021
45020	Nashville Wire Products	Nashville, TN 37202
79264	Jean's Extrusions, Inc.	Salem, IN 47167
2K223	Refrigeration Hardware	Sun Valley, CA 91353
87518	Standard Keil, Inc.	Allenwood, NJ 08720
60886	Idec Corporation	Sunnyvale, CA 94089
19220	Eberhard, Inc.	Cleveland, OH 44136
66682	Cospolich, Inc.	Norco, LA 70079

Table I—Parts List for FSL6T-2M-SN-MLR

	ITEM	COSP#	MFG#	Vendor	QTY	U/M
1	LEFT FEMALE HINGE	HXHE23F	SS09203018LF-104	HOFFMAN	6	EA
2	LEFT MALE HINGE	HXHE23M	SS09203018LM-106	HOFFMAN	6	EA
3	RIGHT FEMALE HINGE	HXHE24F	SS09203018RF-105	HOFFMAN	6	EA
4	RIGHT MALE HINGE	HXHE24M	SS09203018RM-107	HOFFMAN	6	EA
5	DOOR LATCH	HXLH33	64-21-10	SOUTHCO	6	EA
6	DUAL SERVING MODULE	DFM-N	COSPOLICH	COSPOLICH	6	EA
7	BREAKER PANEL ASSEMBLY	RCTL55	COSPOLICH	COSPOLICH	1	EA
8	8" X 6" X 4" ELECTRICAL ENCLOSURE	LENC09	HFFM-A864CHQRFG	NULITE	1	EA
9	8" X 6" X 4" BACK PANEL	LENC09B	MP806S	NULITE	1	EA
10	MALE ELECTRICAL PLUG, 115V	LEP001	612221	BARNETT	6	EA
11	FEMALE ELECTRICAL PLUG, 115V	LER001	612228	BARNETT	6	EA
12	LIQUID TIGHT CONNECTOR	LLTC06	22534	MOTORS & CONTROLS	26	EA
13	15 AMP, 2 POLE BREAKER	PCCC55	S202-B16	MG	6	EA
14	GROUND TERMINAL BLOCK	PCTT008	57.506.9055.0	MG	2	EA
15	DISTRIBUTION BLOCK	RWDB01	1323580	MG	1	EA
16	DIN RAIL	PCTR001	BND1000	MG	1	FT
17	DISTRIBUTION BLOCK ASSEMBLY	RCTL56	RCTL56	COSPOLICH	1	EA
18	10" X 8" ELECTRICAL ENCLOSURE	LENC03	A1086CHQRFG	NULITE	1	EA
19	10" X 8" BACK PANEL	LENC03B	A10P8	NULITE	1	EA
20	THERMOSTAT	RWTT01	T6054A-1005/U	HONEYWELL	1	EA
21	RECEPTACLE, 15 AMP, 125V	RECEP03	627-0121	ALLIED	6	EA
22	ADJUSTABLE LEG	HLEG63	1-1752F260T50S	KASON	8	EA
23	AXIAL FAN MOTOR	RWEM26	4WT46	GRAINGER	2	EA

*Complete Parts List for the Dual Serving Module (DFM-N) is contained within the "DFM-N Dual Serving Module" Technical Manual. This Parts List is for the Flex Serving Line Cabinet only.

Illustrations 6.A & 6.B
Controls & Electrical

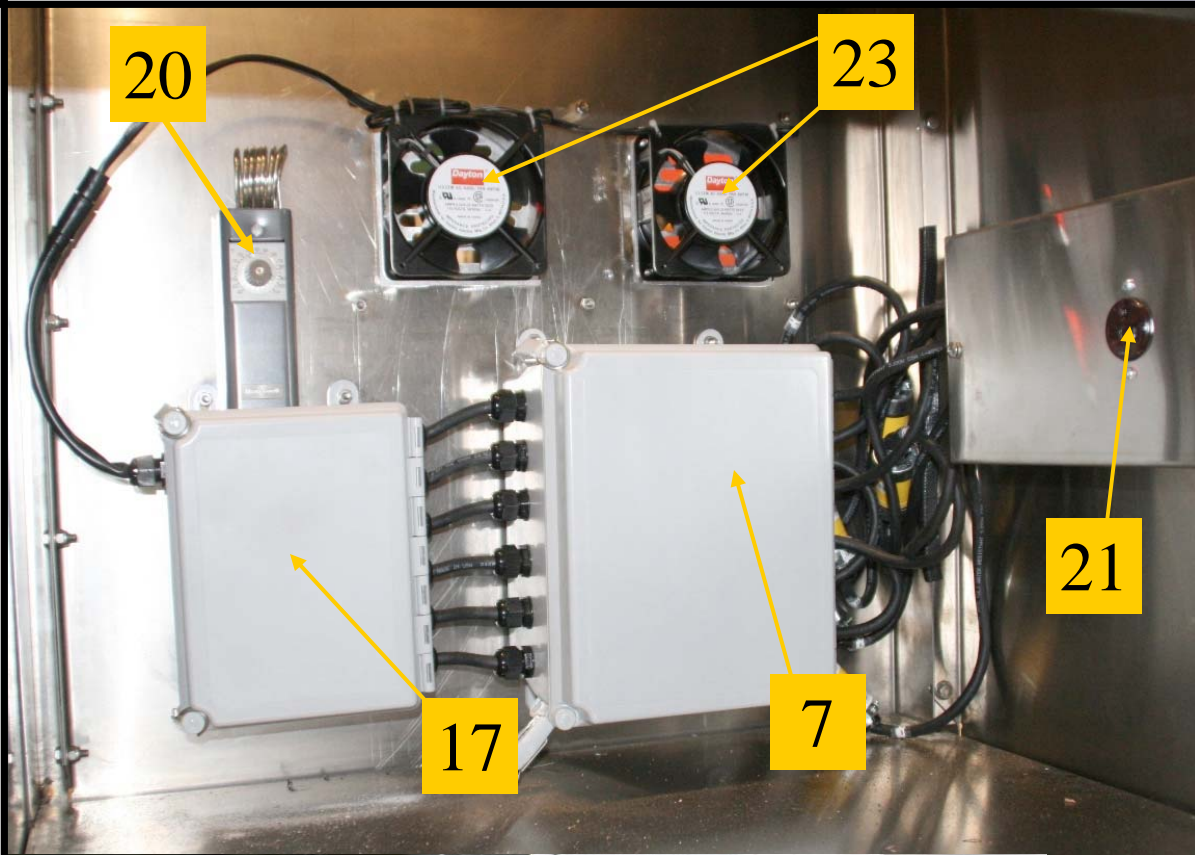

Illustration
6.A

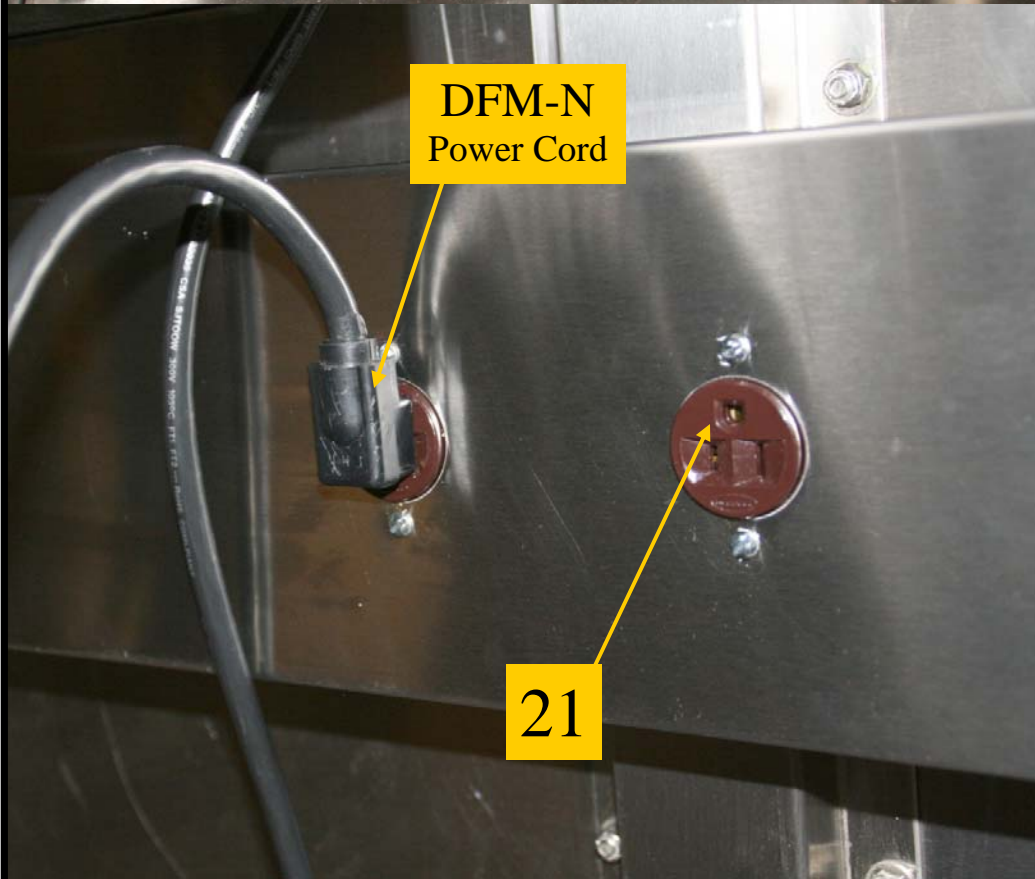

Illustration 6.B

Illustrations 6.C & 6.D Breaker Box Assembly Detail

Illustration 6.C



Illustration 6.D

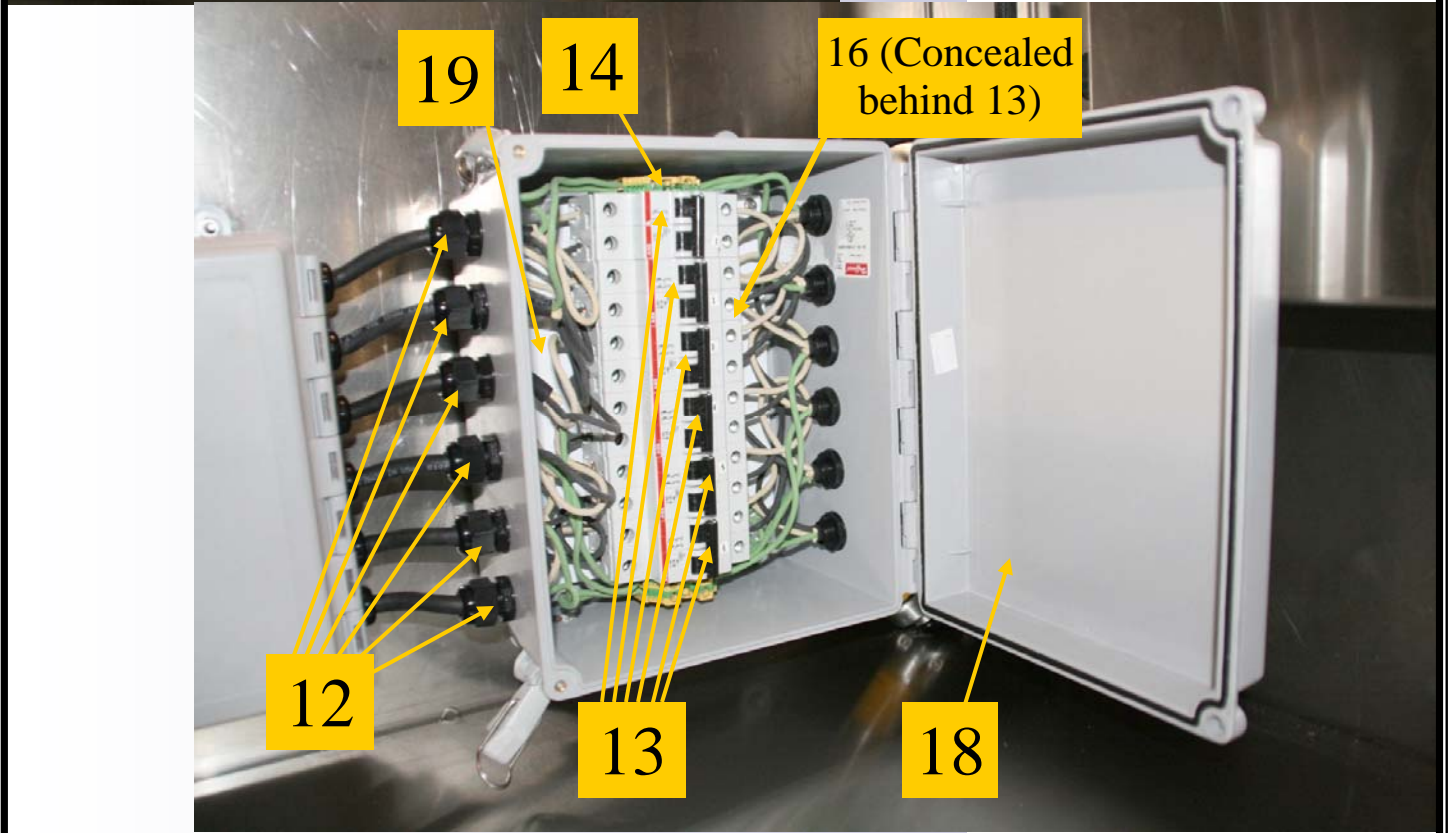

Illustrations 6.E & 6.F – Distribution Block Assembly Detail

Illustration
6.E

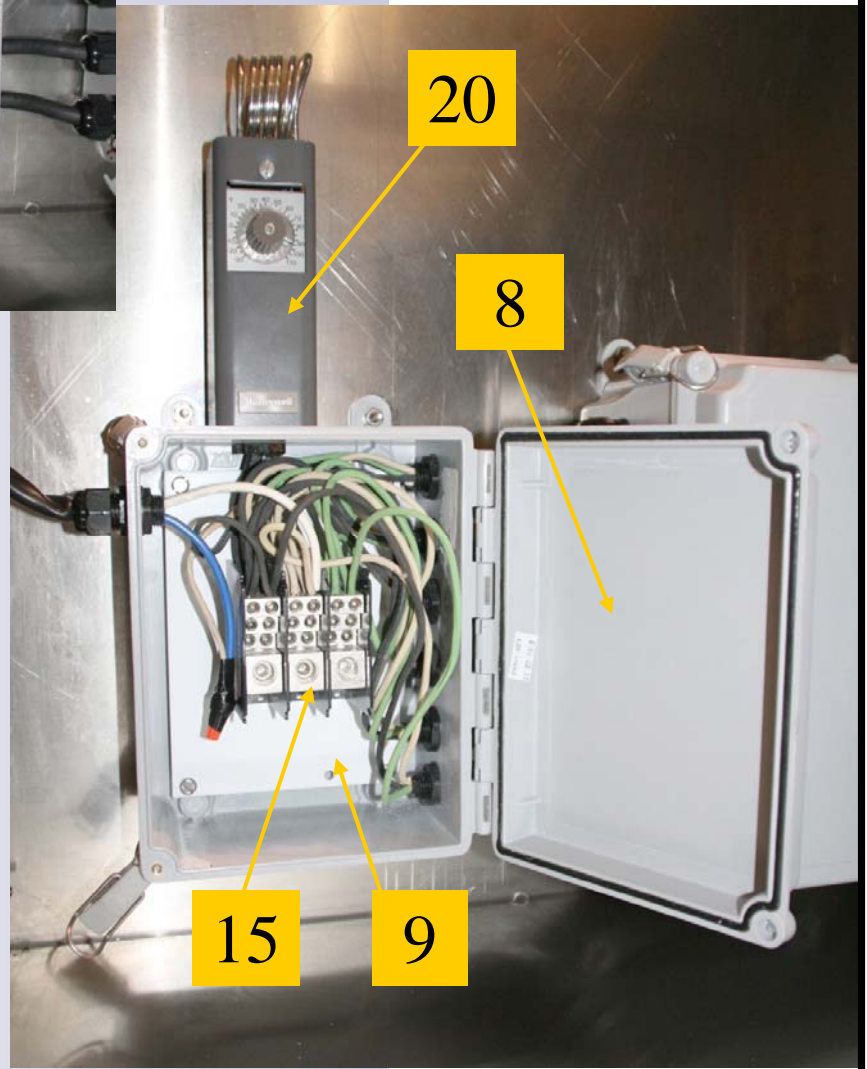

Illustration
6.F

Illustrations 6.G & 6.H – Cabinet & Door Detail



Illustration
6.G-Interior
Door Detail

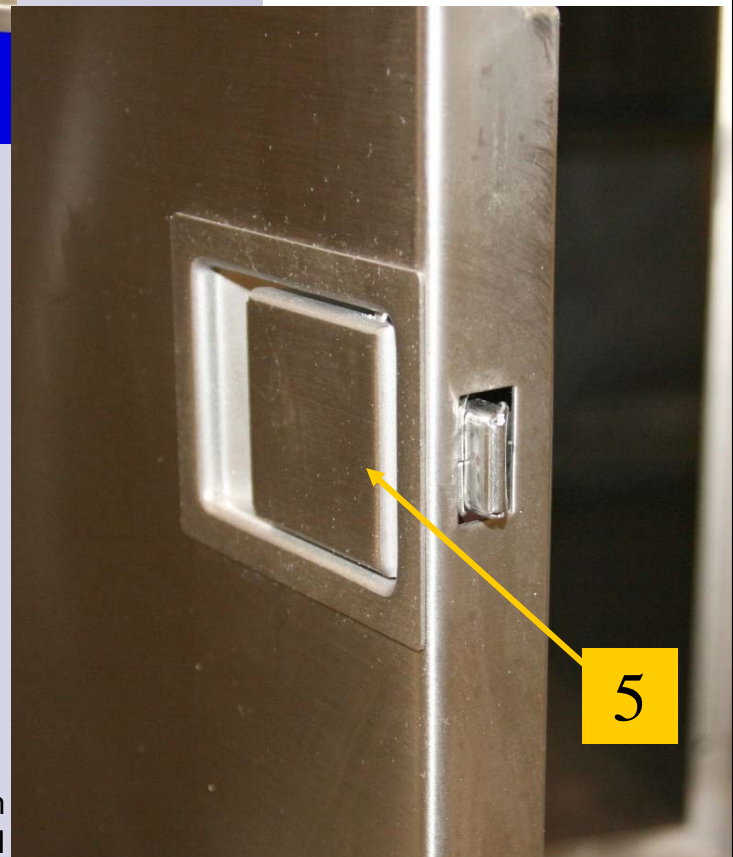

Illustration
6.H

Illustrations 6.I & 6.J—Dual Serving Module Detail (6)

Illustration
6.I



Illustration
6.J



Illustrations 6.K & 6.L – Flexible Serving Line Detail

Illustration
6.K

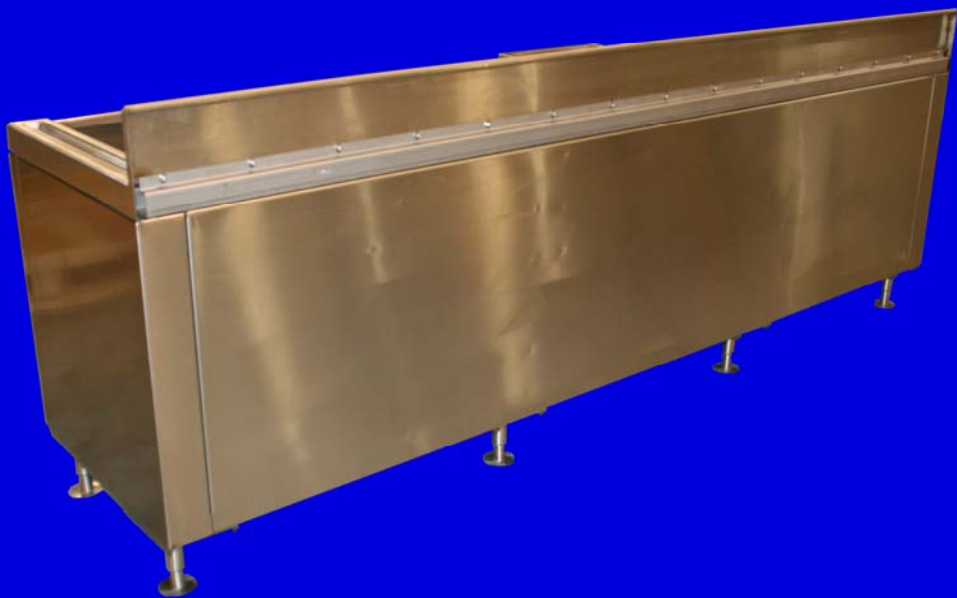

Illustration
6.L

Chapter 7—Installation

7.1 Unpacking

Note: Before unpacking unit, note any crating markings and check for damage to crating and notify the carrier if there should appear to be damage to the equipment.

The unit is shipped from the factory securely fastened to a single shipping pallet protected by an external wrapping.

1. Carefully remove all external wrappings and other protective coverings.
2. Review the installation section of the manual completely prior to installing.
3. Discard crating materials.

7.2 Installation

1. Before moving the unit to the installation site, double-check passageways to make certain that it will move through without modifications.

Note: in certain instances, it may be necessary to remove the doors and hardware to negotiate tight spaces.

2. On most shipboard applications, a permanent base is fabricated by the ship builder to accommodate the base frame of the unit. If required Cospolich can furnish a foundation which can be attached to the deck. **Note: Not required on units with legs**
3. Once the cabinet has been attached to the ship's foundation, it is necessary to apply a silicone sealant around the complete perimeter at the point that the cabinet base contacts the foundation. **Note: Not required on units with legs**
4. Position the unit to allow sufficient ventilation, usually leave a 1" clearance from adjacent bulkheads and other equipment.
5. Level the cabinet from front to back and from side to side. This is important so that when securing to the deck base, the cabinet will not be pulled out of square.
6. Before applying electrical power to the unit, you should first check the electrical characteristics of the appliance and make certain that they agree with those of the electrical supply source. **CAUTION: LOW OR EXCESSIVE VOLTAGE CAN SEVERLY DAMAGE THE ELECTRICAL SYSTEM.**

Chapter 8 – Modular Installation

8.1 Introduction

By design the modular version of the Flexible Serving Line Unit has been engineered and manufactured to be disassembled and reassembled aboard ship. By following these instructions you can be guaranteed a successful installation. Should questions arise or assistance be needed contact Cospolich customer service at (800) 423-7761 or (985) 725-0222. Email cospolich@cospolich.com

8.2 Installation Skill Level

In general the skill level of the installer should be of a journeyman class in the area of mechanic. The primary process will require the following written instructions, use of common tools, and the proper fitting and alignment of the components. The electrical portion of the installation will be minimal, only requiring the unit to be plugged in and all electrical voltages verified.

8.3 Tools

Common tools required are standard/Phillips screwdrivers and wrenches. If the equipment is to be attached to a foundation, it may be necessary to drill holes.

8.4 Disassembly

NOTE: If the unit is to be disassembled prior to installation, please call Cospolich at (985) 725-0222 for assistance with disassembly and reassembly.

Chapter 9 – Electrical and Mechanical

9.1 Introduction

This section of the manual contains drawings and schematics of the electrical and piping systems.

Illustration 9.A-Electrical Schematic

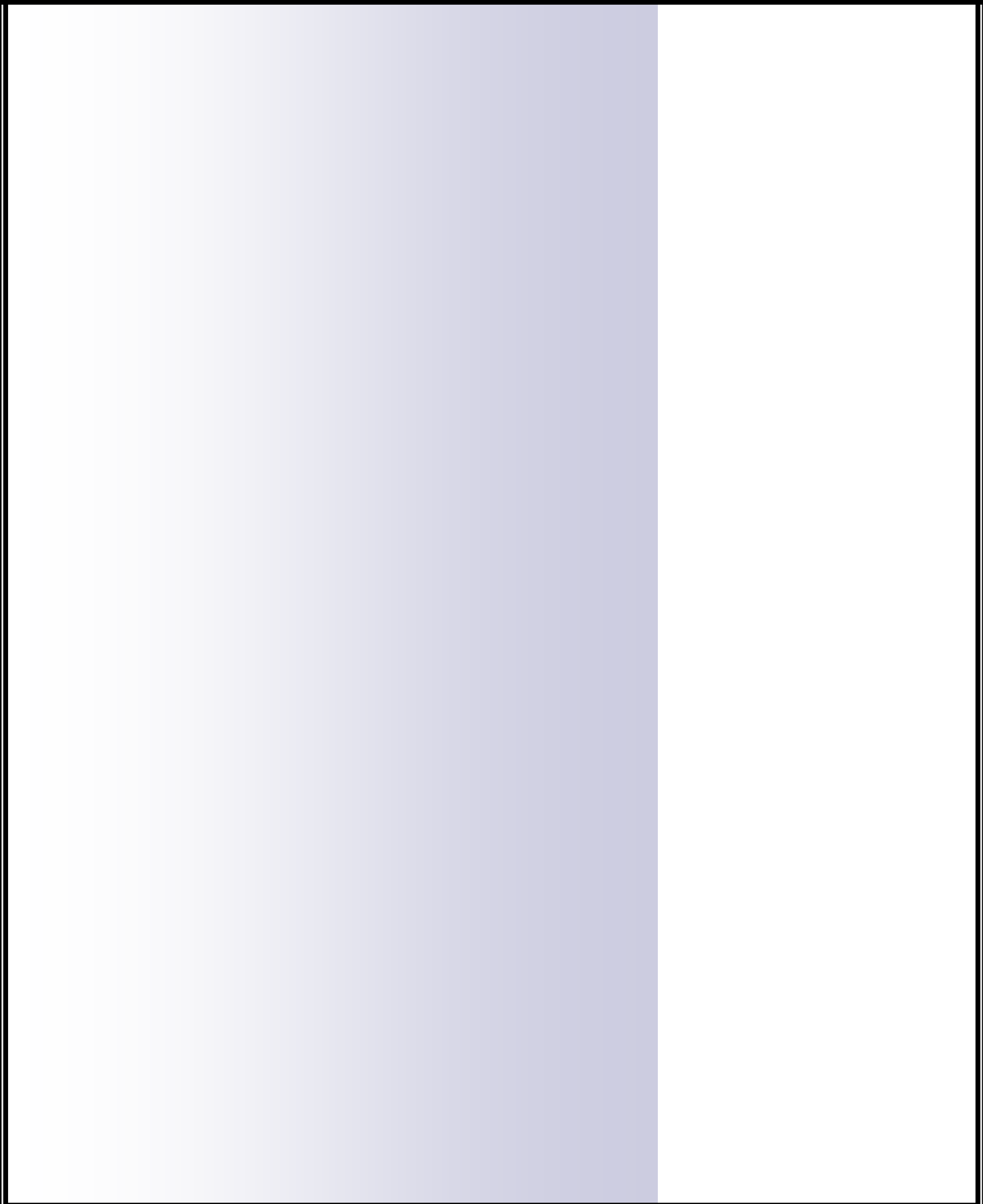
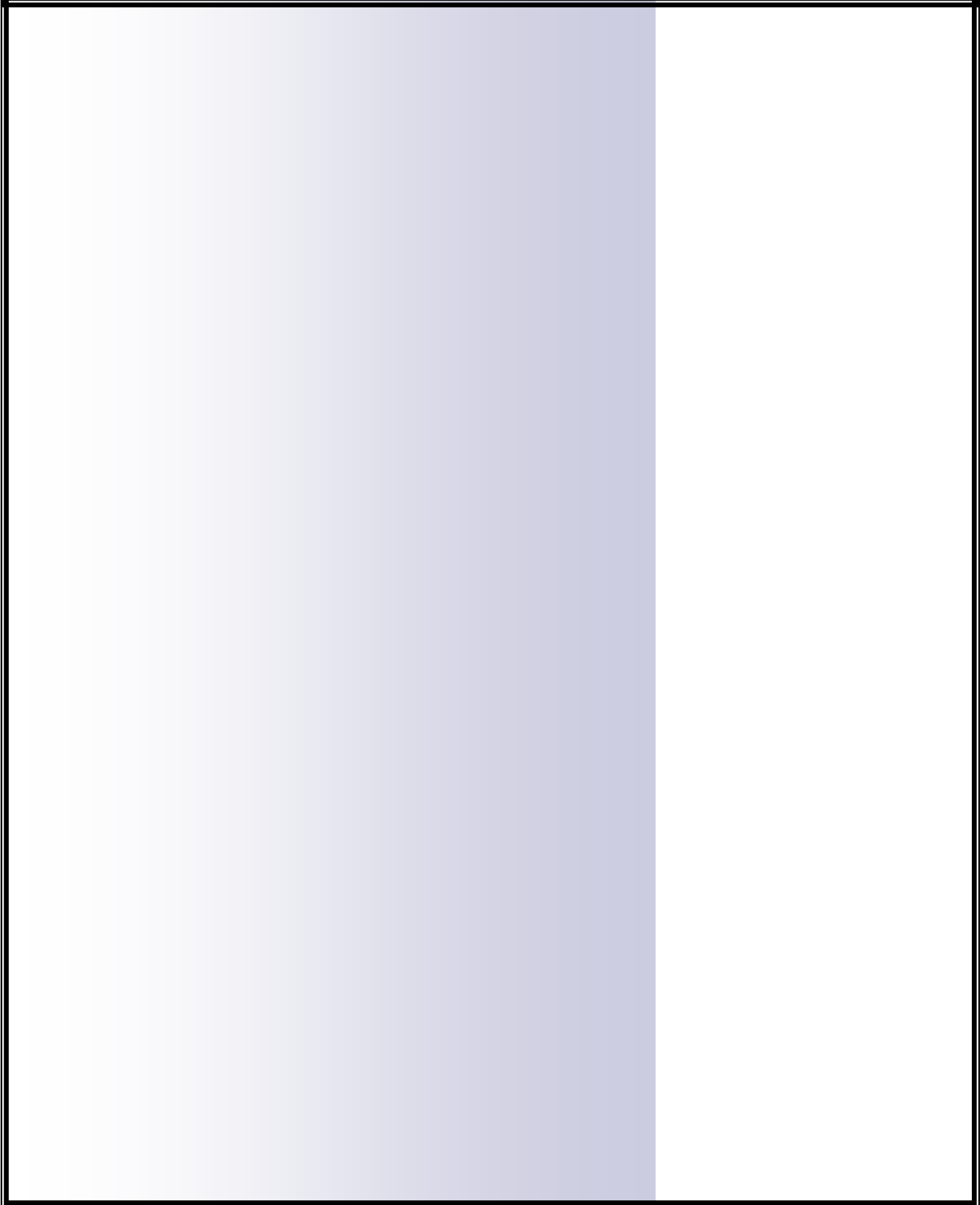

Illustration 9.B-Electrical Schematic-Dual Serving Module



Chapter 10—Limited Warranty

Cospolich Inc. warrants their cabinets to consumers against defects in material or workmanship under normal use and service for a period of one year from the date of the shipment. We will repair or replace at our option, any part, assembly or portion thereof which Cospolich's examination discloses to be defective. Cospolich will pay the labor costs for the repair up to twelve (12) months from date of shipment.

In instances where the purchaser is not the owner in possession and the acceptance of Cospolich equipment is closely tied to the completion and delivery of the project, our warranty will begin on the acceptance date and will extend for one year.

Terms

Exclusions

Cospolich's obligations under this warranty shall not extend to any malfunction or other problem caused by unreasonable use, such as but not limited to, improper setting of controls, improper installation, improper voltage supply, loose electrical connections or blown fuses, and damage not attributable to a defect in workmanship. This warranty shall not apply to any cabinet or component part that has been suspect to any accident, alteration, abuse, misuse to any damage caused in fire, flood, or other acts of God and to any product that has been serviced by an unauthorized service person or company.

To secure Warranty Service

If you claim a defect under this warranty, direct your claim to whom you purchased the product, giving model, serial and code numbers with a description of the problem. Telephone calls should be directed to the service department at (800) 423-7761 or (985)725-0222 with fax request going to (985) 725-1564.

If the above procedure fails to satisfy your claim, you may write directly to the following address including the above identifying information.

**DIRECTOR of CUSTOMER RELATIONS
COSPOLICH INC.
P.O. BOX 1206
DESTREHAN, LA 70047**

There is not other express warranty on the Cospolich units except the terms stated herein. Any implied warrants of fitness and merchantability are limited in duration to the duration of this Warranty. The liabilities of Cospolich are limited solely and exclusively to replacement as stated herein and do not include any liability for any incidental, consequential or other damages of any kind whatsoever, whether any claim is based upon theories of contract negligence or tort. Some states do not allow limitations on how long an implied warranty lasts, or the exclusion of limitations of incidental or consequential damages. So the above limitations and exclusions may not apply to you. This warranty gives you specific legal rights and you may also have other rights that vary from state to state.